

**Z KOVE**

**450 RALLY**  
TOUCH THE DREAM



Two-wheeled motorcycle instruction manual

Tibet New Summit Motorcycle Co.,Ltd

## To the owners

### Two-wheeled motorcycle instruction manual

#### The second edition ( NOV. 2022 )

First of all, congratulations on your purchase of a new Kove brand motorcycle!

By choosing a Kove motorcycle product, you have become a member of the Kove Motorcycle family.

The instruction manual introduces the main specifications, basic structure, adjustment methods and maintenance knowledge of the motorcycle. It will guide you to master the basic operation of the motorcycle as well as troubleshooting or reducing common faults, which will effectively guarantee the safety of driving, bring out the best performance of the vehicle, and improve the service life of the vehicle.

This manual contains the basic configuration of the motorcycle, the content and pictures are for reference only, please refer to the real thing.

Due to the factory time, user requirements and design improvements, etc., may lead to differences between the actual vehicle and the manual content, we reserve the right to make changes at any time without further notice or obligation, so please understand the inconvenience caused.

The instruction manual is one of the necessary accessories for the motorcycle and should be attached to the vehicle when reselling it to another person.

The copyright of this manual belongs to the company, without the written consent of the company is not allowed to reprint, violators will be investigated.

To ensure your safety and increase your riding pleasure :

- Please read this instruction manual carefully.
- Please follow all recommendations and procedures in the instruction manual.
- Please pay close attention to the safety information written in the instruction manual and pasted on the motorcycle.

## Security precautions

Your safety and the safety of others is important, and riding this motorcycle safely is an important responsibility. To help you make informed decisions about your safety, we have provided procedures and other information on the safety label and in the instruction manual that will alert you to potential hazards that could harm you or others.

Of course, it would be impractical for us to list all the dangers associated with motorcycle riding and maintenance, and you must make the correct judgment.

The addition of electrical equipment is prohibited because the battery used in this motorcycle is a lithium battery, which has a small capacity and may result in a loss of power if electrical equipment is added.

This motorcycle is equipped with a high-speed engine, and for your driving safety, it is recommended that you reduce violent driving.

You will see important safety information in various forms, including :

- Safety label on the body of the motorcycle ;
- The safety message is preceded by a safety warning symbol  and one of the following three warnings: CAUTION, DANGER, WARNING.

The meanings of the three warning phrases are shown below :

 CAUTION -if you don't follow the instructions, you may be injured.

 DANGER -if you don't follow the instructions, it will result in serious injury or death.

 WARNING -if you don't follow the instructions, it will result in serious injury or death.

Additional important information is listed below the following headings :

**NOTE** -information to help you avoid damage to your motorcycle, other property or the environment.

# Catalog

Motorcycle Safety .....	4
Operation Guide .....	13
Maintenance .....	28
Troubleshooting .....	62
Related Information .....	71
Technical Parameters .....	81

# Motorcycle Safety

This section contains important information for safe motorcycle riding, please read this section carefully.

Security Guide .....	5
Safety Precautions .....	8
Riding Precautions .....	9
Accessories and modifications .....	12
Loading Guide.....	12

## Security Guide

To enhance the safety of your ride, please follow these guidelines :

- Perform all daily and routine checks specified in the operating instructions.
- Before refilling the fuel tank, turn off the engine and keep it away from sparks and open flames.
- Don't start the engine in a confined or semi-confined space because the exhaust gases contain carbon monoxide, a toxic gas that can be fatal.

## Always wear a helmet

Helmets and protective clothing have been shown to significantly reduce the chance of injury to the head and other parts of the body, and to reduce the extent of injury. Therefore, always wear a certified motorcycle helmet and protective clothing when riding.

## Before Riding

Make sure you are in good physical condition, focused, and have not been drinking or taking drugs. Wear a certified motorcycle helmet and protective clothing, keep your hands on the steering handlebars and your feet on the pedals, and lean your body when turning, even when the motorcycle is stopped.

## Take the time to learn and practice

Even if you have ridden other motorcycles, practice driving this motorcycle in a safe area to become familiar with the operation and handling of this motorcycle and to adapt to the size and weight of the motorcycle.

## Be aware of protection when riding a bike

Always be aware of the vehicles around you, don't assume that other drivers can see you, and always be prepared to apply emergency brakes or dodge detours.

## Make yourself easily seen

Especially at night, wear bright reflective clothing to make yourself more visible, stop where other drivers can see you, turn on your signal before turning or changing lanes, and honk your horn to alert pedestrians when necessary.

## Do not drink and drive

Never ride beyond your personal capabilities or exceed the speed limit set by your motorcycle. Fatigue and negligence can impair your ability to make good judgments and ride safely.

## Keep your motorcycle in safe condition

It is important to keep your motorcycle in good condition at all times; check your motorcycle before each ride and complete all recommended maintenance and repairs, do not modify your motorcycle or add accessories that would affect safety, and strictly prohibit overloading.

## Dealing with unexpected events

Your personal safety is your first priority. If you or anyone else is injured, you should first carefully assess the severity of the injury and determine whether it is safe to continue riding. If necessary, call for emergency assistance. When other people or vehicles are involved in a collision, you should also follow the laws and regulations that apply.

If you decide to continue riding, first turn the ignition switch to the  " (off) position, then assess the condition of the motorcycle, check for oil leaks, check that key nuts and bolts are tight, and check the steering handle, steering column, brakes and wheels, and ride slowly and carefully. .

Your motorcycle may have sustained damage that is not immediately apparent, so please take it to an authorized Kove motorcycle repair store or a qualified repair store for a thorough inspection as soon as possible.

## Carbon monoxide hazards

The exhaust contains toxic carbon monoxide, a colorless and odorless gas that can cause unconsciousness and may even be fatal if inhaled.

If you start your engine in a confined or semi-confined space, the air you inhale may contain dangerous amounts of carbon monoxide.

Never start the engine in a garage or other confined space.



### Warning

- Running a motorcycle engine in a confined or semi-confined space can lead to a rapid build-up of toxic carbon monoxide gas.
- Inhalation of this colorless and odorless gas can cause rapid loss of consciousness and death.
- Start the motorcycle engine only in a well-ventilated outdoor area.



## Safety Precautions

- Drive carefully, always keep your hands on the steering handle and your feet on the pedals.
- Always pay attention to driving safety, try to stay away from all kinds of vehicles, avoid pedestrians and slow down.
- Observe basic driving rules and drive on the right.

Never carry a passenger. Your motorcycle is designed for single riders, and carrying a passenger may cause an accident in which you and others may be injured.

## Protective clothing

Make sure you are wearing a certified motorcycle helmet, goggles and visible protective clothing, and ride carefully according to weather and road conditions.

### Helmets

Certified by safety standards, eye-catching and sized to fit your head.

- Must be secure and comfortable and held in place with a chin strap.
- Face shield or other certified goggles that do not obstruct vision.

### ■ Gloves

High abrasion resistant full finger leather gloves.

### ■ Boots or riding shoes

Sturdy and slip-resistant boots that protect the ankle.

### ■ Clothing

Eye-catching long-sleeved shirt and durable pants(or protective suit) with protective effect for riding.

## 警告 Warning

- Not wearing a helmet increases the chances of serious injury or death in an accident.
- Make sure you always wear certified helmets and protective clothing.

## Riding Precautions

### Break in period

Follow these guidelines during the first 500 miles of driving to ensure reliability and performance later in the motorcycle's life.

- Avoid full throttle starts or rapid acceleration.
- Avoid emergency braking and rapid downshifting.
- Ride with caution.

### Brake

**Follow these guidelines :**

- Avoid excessive emergency braking and downshifting
  - ▶ Sudden braking can reduce the stability of your motorcycle.
  - ▶ Slow down before turning, or you risk slipping and falling.
    - Always ride carefully on slippery roads
  - ▶ Tires on such surfaces are more likely to skid and require longer braking distances.
    - avoid continuous braking
  - ▶ When going downhill on long and steep slopes, repeated braking will cause the brakes to seriously overheat and affect the braking effect, so the brakes should be used intermittently to slow down with the help of engine braking.
    - Using both front and rear brakes can achieve complete braking effect.

## I Anti-lock Braking System ( ABS )

This model is equipped with an anti-lock braking system, which prevents the brakes from locking up during emergency braking.

- The ABS does not reduce the braking distance.

In some cases, the anti-lock braking system may result in longer stopping braking distances.

- The anti-lock braking system does not work when the vehicle speed is below 10 km/h.
- When braking, it is normal that the brake handle or rear brake pedal may bounce gently after the ABS intervenes.
- Always use the recommended tires to ensure that the anti-lock braking system will operate correctly.

## I Engine Brake

When you release the throttle, the engine brake will help the motorcycle slow down. If you want to slow down even more, you can downshift to a lower gear; when going downhill on long and steep slopes, you should slow down with the help of the engine brake and use the brake intermittently.

## I Humid and rainy environment

In wet and rainy conditions, the road will be slippery and wet brakes will reduce braking efficiency, so be extra careful when braking. If the brakes are wet, you can intermittently and repeatedly brake while driving at low speeds, which helps to dry the brakes quickly.

## Parking

- Park on a firm, level surface.
- If you must park on a slightly sloped or loose surface, make sure it is firmly parked and that the motorcycle cannot move or tip over.
- Make sure that hot parts do not come into contact with flammable materials.

- Do not touch the engine, muffler, brakes and other hot parts until they have cooled down.
- To avoid the possibility of theft, always lock the steering handlebars and remove the keys before leaving the motorcycle unattended.

**■ Parking with side stand**

1. Turn off the engine.
2. Lower the side stand.
3. Slowly lean the motorcycle to the left until its weight is concentrated on the side stand.
4. Turn the steering handle completely to the left.

▶ Turning the steering handle to the right will reduce stability and may cause the motorcycle to fall over.

5. Turn the ignition switch to the  (locked) position and remove the key.

**Refueling/Brake Fluid and Fuel Guide**

Follow these guidelines to protect your engine and catalytic converter :

- Use only unleaded gasoline.
- High octane gasoline is recommended; use of lower octane gasoline will reduce engine performance.
- Ethanol gasoline is not recommended; using ethanol gasoline can reduce engine performance.
- Do not use spoiled or contaminated gasoline, or oil-gasoline mixtures.
- Prevent dirt and water from entering the fuel tank.
- Brake fluid has a corrosive effect. When adding it, be sure to avoid splashing in the eyes, adhering to the skin and avoiding contact with non-metallic materials of the vehicle.

## Accessories and modifications

We strongly recommend that you do not add accessories to your motorcycle other than those designed specifically for your motorcycle by Kove, and do not modify the original design of your motorcycle, as doing so may render it unsafe. Unauthorized modifications to your motorcycle may also void your warranty and render your motorcycle illegal to drive on public roads and highways. When you decide to add accessories to your motorcycle, first determine which modifications are safe and legal.

It is prohibited to attach a trailer or add a straddle bucket to your motorcycle; it is prohibited to modify or add other equipment at the engine mounting point. Your motorcycle is not designed for these accessories and their use can seriously damage the handling and safety of the motorcycle

**警告** Warning

- Improper accessories or modifications may cause safety accidents in which you may be seriously injured or even endanger your life.
- Please follow all instructions in the instruction manual for accessories and modifications.

## Loading Guide

- Carrying extra weight can affect the handling, braking and stability of your motorcycle. Please be sure to maintain a safe speed when riding with a heavy load.
- Please stay within the specified loading limits, the maximum payload for the entire bike is 75kg, do not overload.
- Secure all luggage and place it evenly and smoothly near the center of the motorcycle.
- Do not place items at the lights or muffler.

**警告** Warning

- Overloading or improper loading can lead to accidents and serious injury or death.
- Please follow the loading instructions in the instruction manual for loading.

## Operation Guide

This section contains important information on the operation of motorcycle use, please read this section carefully.

Parts location diagram .....	14
Instrument .....	16
Switch .....	22
Ignition Switch .....	24
Start the engine .....	25
Shift .....	26
Refueling .....	27

Parts location map

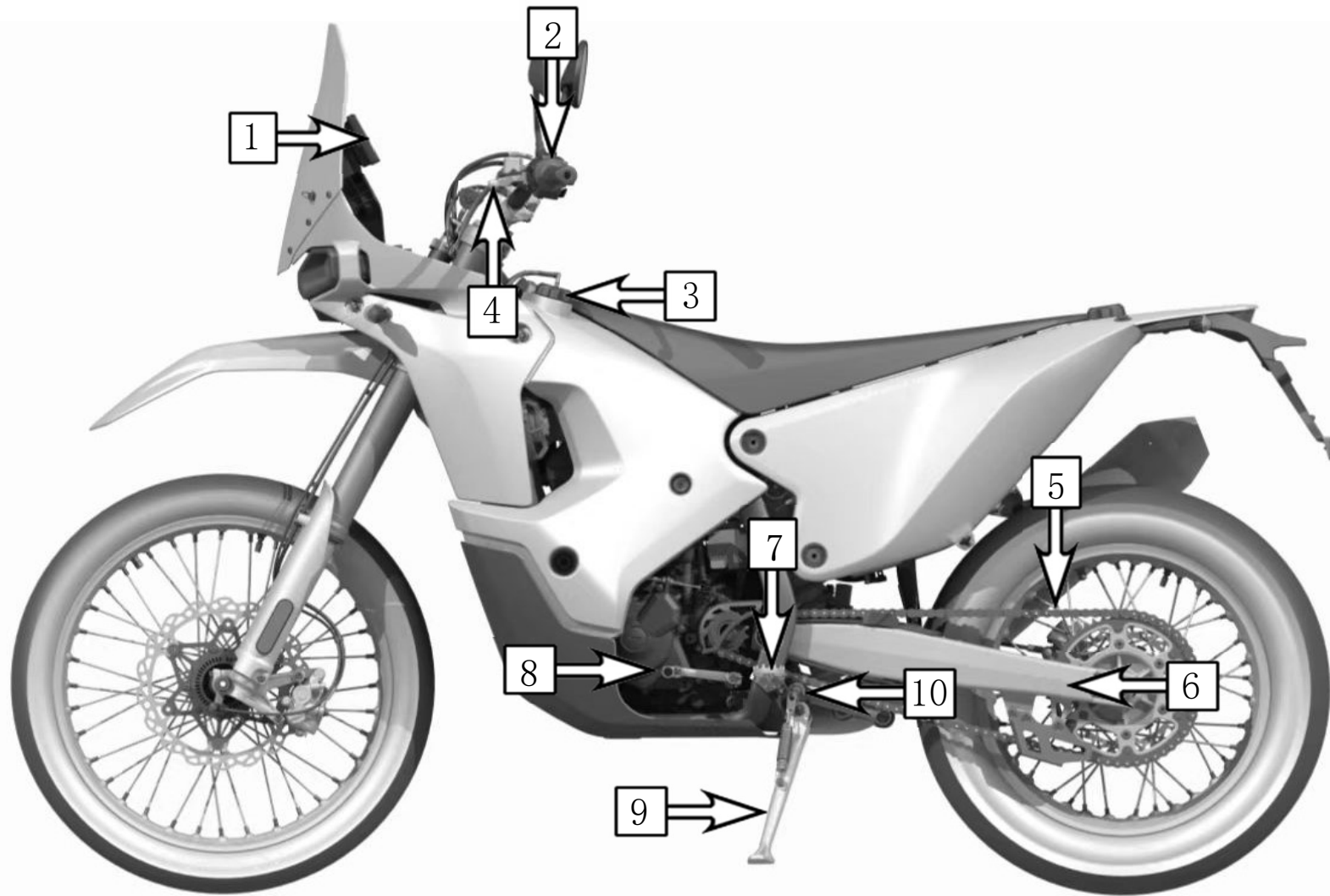

1.Instrument Assembly 2.Left handle switch 3.Fuel tank cover 4.Clutch handle 5.Chain 6.Flat fork 7.Left front footrest 8.Shift pedal 9.Side bracket 10.Side bracket flameout switch

Parts Location Diagram

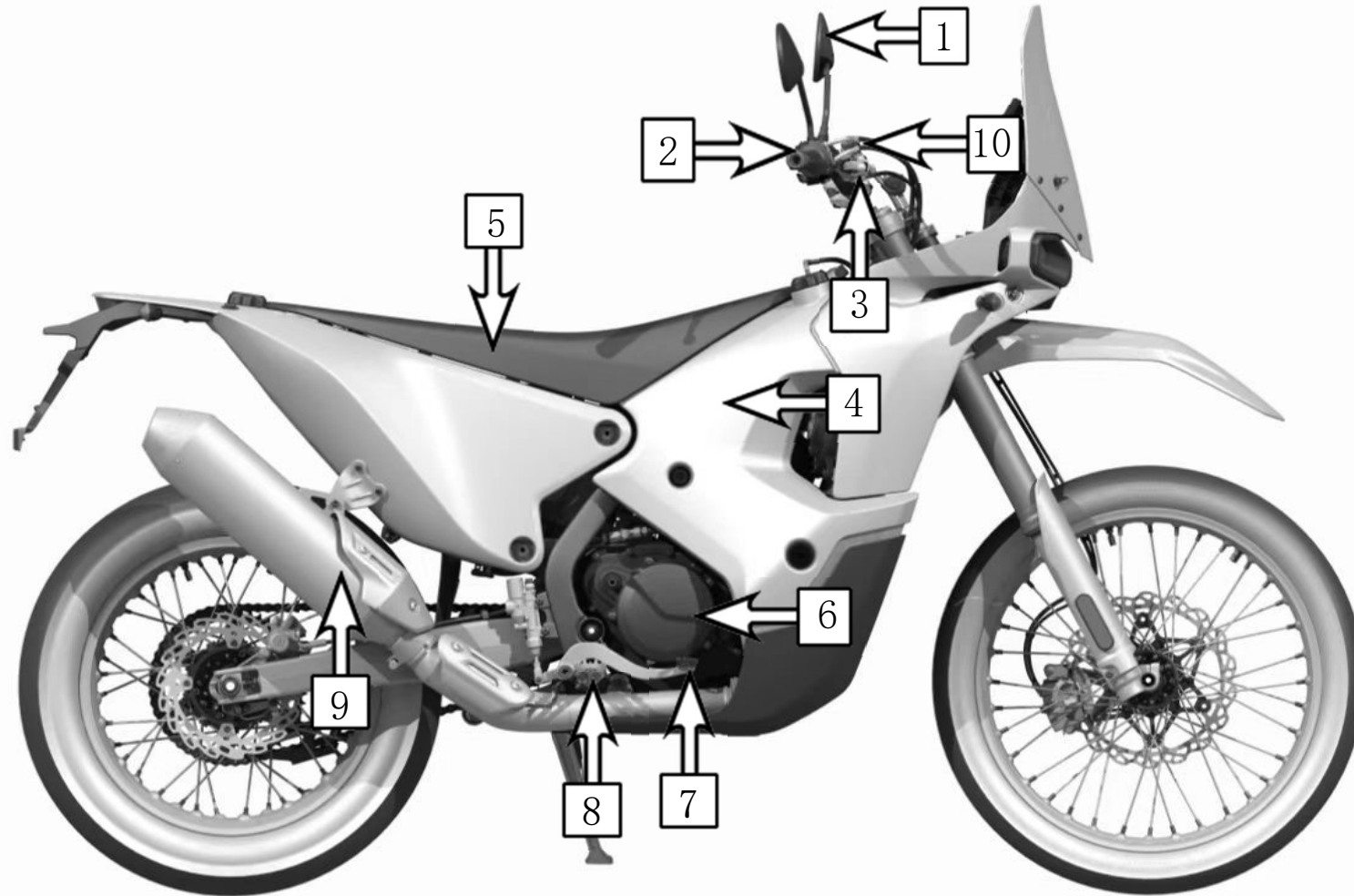

1.Rearview mirror 2.Right handle switch 3.Brake handle 4.Fuel tank 5.Cushion 6.Engine 7.Rear brake pedal 8.Right front footrest 9.Muffler 10.Front brake fluid reservoir



Instrument



Display Check

When the ignition switch is turned to "ⓐ" (on), the instrument is energized to play the power-on animation, followed by a self-test, and all function modules and symbols are displayed; if the display is missing during the self-test, please refer to the special repair store for the Escalade locomotive for repair.

Instrument Interface



No.	Name	Remark
1	steering light	The left indicator flashes when the left turn signal comes on
		The right indicator flashes when the right turn signal comes on
2	Message display	Location message display(after connecting with Bluetooth headset)
		②Fault message display(when a fault occurs)
		③APP message push(need to be set in the mobile app)
		④Caller ID display ( after connecting with Bluetooth of cell phone )
3	Tachometer	Engine speed display
4	Neutral indicator	The light comes on when in neutral
5	Speedometer	Display the current speed in km/h
6	ABS fault indicator	①The light comes on when there is a fault ②After the whole motorcycle is powered on, this light flashes(0.5s on, 0.5s off) as a normal phenomenon, when the speed exceeds 5km/h, ABS self-test will go off.
7	Gear indication	Show the current gear
8	ABS status display	Front and rear wheels show white outline: ABS on front and rear wheels.
		Rear wheel shows yellow fill: rear wheel ABS off
		Front and rear wheel shows yellow fill: ABS off for front and rear wheels.
9	Low voltage indicator	The light comes on when the battery voltage is too low
10	Automatic headlights	The light comes on when the automatic headlight function is on
11	Bluetooth and network display	Light up after connecting with Bluetooth or wifi of cell phone( gray symbol when not connected)

Instrument Interface



No.	Name	Remark
12	Maintenance indicator	This light comes on when the motorcycle reaches the <u>maintenance setting condition</u>
13	Water temperature display	①When the water temperature is lower than 0°C, the first frame flashes, at this time, you need to confirm whether the coolant is frozen or not, after confirming normal, you can start
		②When the water temperature indicator block shows red and lights up the "water temperature warning light", it means that the water temperature is too high, ensure safety, stop and check, wait for the water temperature to drop before continuing to drive
		③When the water temperature data is abnormal, all water temperature color blocks and icons will flash together. (Blinking is normal when the flameout switch is off)
14	Fuel display	Shows how much fuel is available
		①When the oil level is below 1 cell (after a period of continued use, the red oil level will flash along with the oil level symbol), please replenish the fuel as soon as possible
15	Temperature display	Display after Bluetooth connection with cellphone
16	Weather display	Display after Bluetooth connection with cellphone
17	Time display	Display the time of the instrument
18	Vehicle data/ Easy navigation	Vehicle data display(when not navigating)
		Simple navigation display (need to connect the cell phone Bluetooth, and set the navigation in the cell phone side of the special APP)
19	Water temperature warning indicator	The light comes on when the water temperature is too high
20	EFI fault indicator	This light comes on when there is a fault in the EFI system (this light comes on when the engine is powered up. After normal start, this fault light goes off as normal)
21	High beam indicator	The light comes on when the high beam indicator is turned on
22	Position light	The light comes on when the position light is turned on

Instrument Full-screen Navigation Interface



No.	Name	Remark
1	Message prompts	Fault message prompt, APP push message prompt, call prompt
2	Navigation interface	Displays the full-screen navigation screen
3	ABS status display	Front and rear wheels show white outline: Front and rear wheels ABS on, rear wheels show yellow fill: Rear wheel ABS off Front and rear wheels show yellow fill: Front and rear wheel ABS off
4	Gear indication	Displays the current gear
5	Oil level indication	Displays the amount of fuel remaining

## Menu description

Primary menu	Secondary menu	Description
ABS setting	Turn on the front and rear wheels	Set the ABS working status, and the current ABS working status is displayed through the instrument icon.
	Turn off the rear wheels	
	Close the front and rear wheels	
Riding data	Subtotal mileage	Set the vehicle data display items on the main interface, and the selected items are displayed on the first page first (after the number exceeds the number of displayed columns, they are automatically rowed back), and the unselected items are arranged on the next page. Weather conditions can be set to show on or off. Note: 1. The average speed = 0, the average speed shows "--"; 2. The average fuel consumption is affected by many factors such as vehicle working conditions and riding habits, and the display data is for reference only; 3. Long press the BACK button to pop up the subtotal mileage clearance menu, and follow the prompts.
	Average vehicle speed	
	Average fuel consumption	
	Ride time	
	voltage	
Setting	Bluetooth/WIFI connection settings	Set up Bluetooth/WIFI connection with mobile phone (in order to ensure normal connection, the mobile phone dedicated APP needs to open relevant permissions according to the prompts; When WIFI is connected, you cannot choose to use the meter WIFI to surf the Internet, otherwise it will affect the mobile phone Internet function)
	Screen display	Display mode: Users can modify the instrument display interface according to their preferences.
		Display brightness: Users can modify the display brightness of the meter according to their preferences.
	Headlight mode	When "Automatic Headlights" is selected in the "Headlight Mode" menu, the headlight switch is automatically controlled according to the ambient brightness after the engine is started.
		When the automatic "Headlights are solid" in the "Headlight Mode" menu, the engine starts and the headlights turn on.
		When selecting "Manual Headlights" in the "Headlight Mode" menu, return to the main interface, and in the first level menu, you can switch the headlight switch.
	Time/date	The instrument's time/date can be set manually by the user. If you select Automatic, when connected with the phone's Bluetooth, it will automatically synchronize with the phone's time.
	Language	Chinese and English menu switching.
Maintenance service	Maintenance mileage or time setting and clearing: the first 2000km, every 500km or 3 months reminder, this default parameter cannot be modified. After that, the user can set the maintenance reminder period according to the actual situation (the default value is every 2000km or 6 months). Maintenance prompt removal method: Press and hold the SET key under the maintenance service interface to pop up the clearing dialog box, and follow the prompt content.	
Unit conversion	Display unit switching.	

The instrument functions are operated as follows:

### Vehicle data viewing:

Under the main interface of the instrument, you can turn the page by pressing the up and down keys to view vehicle-related data.

#### Information view:

1. When the main interface appears with an information prompt (for example: fault message), you can press SET to view the details, and press the BACK button to clear.
2. When connected with the Bluetooth connection of the mobile phone, the message display section will reflect the mobile phone push information, short press the SET key to view details, short press the BACK button to clear.

#### Instrument navigation operation:

When normally connected with mobile phone Bluetooth/WIFI, and after setting navigation on the dedicated APP on the mobile phone, press and hold the up button to enter the instrument full-screen navigation, long press the key to enter the instrument simple navigation, and short press the BACK key to exit the instrument navigation interface.

#### Feature settings:

Press the SET key briefly to enter the gauge menu. ABS mode, instrument brightness, riding data, automatic headlights (on or off), time, language and other parameters can be set according to the man-machine dialogue menu.

#### Instrument and mobile phone interconnection:

1. The positioning function, navigation function, information push function, weather function, automatic time function, altitude display and other functions in the TFT instrument need to be connected with the mobile phone with the relevant APP installed.
2. Mobile APP installation steps: (1) Enter the instrument setting menu; (2) Select Connection Settings; (3) Select Bluetooth connection, use the Internet-connected mobile phone to scan the QR code in the interface, and download and install the APP according to the prompts. (In order to get a better experience, when using the mobile app, please pay attention to the APP related usage help.)
3. When the meter needs to be disconnected from the connected mobile phone, enter the reset connection menu and select disconnect Bluetooth or disconnect WIFI.

#### Attention

You need to modify the ABS mode, which must be done while it is parked.

## Switch

### Left handlebar switch

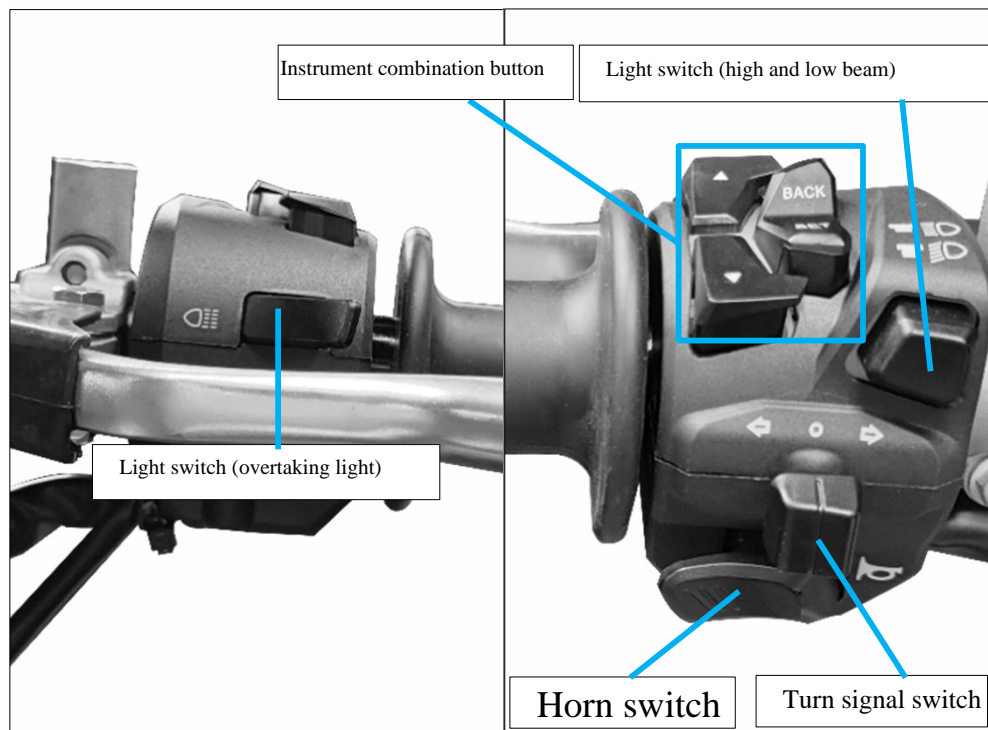

Instrument combination button:

This combination button is used to set the functions of the meter :

▲▼ The function selection toggles up and down

BACK Back button

SET Set the instrument function button

### Light switch:

- Turn on the overtaking light (the overtaking light switch is located on the back of the handlebar switch)
  - ☰☷ Turn on high beam
  - ☷☷ Turn on low beam

### Turn signal switch

- ☞ Turn signal on left: Toggle the switch to the left, and after operation, the turn signal switch Return to the original location.
- ☛ Turn on the right turn signal: Toggle the switch to the right, and after operation, the turn signal switch Return to the original location.
- Turn signal off: When the turn signal switch is in the middle position, press this button to turn off the turn signal

**Left handlebar switch**

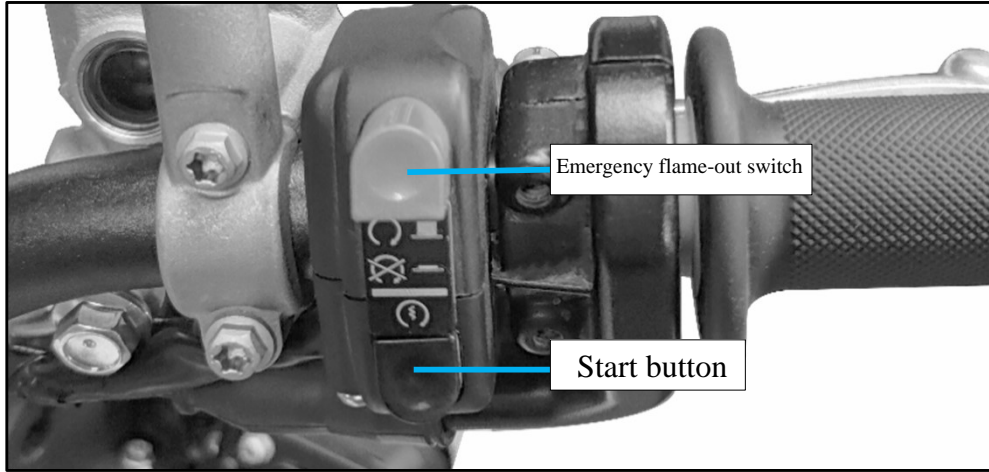

**Emergency flame-out switch :**

The engine can only be started when the switch is in the "○" (running) position; When the switch is in the "⊗" (stop) position, the engine does not start.

▶ In case of emergency, switch to the "⊗" (stop) position to extinguish the engine.

**Start button:**

When the emergency kill switch is set to the "○" position:



- (1) The engine is in neutral, press this button to start the engine.
- (2) If the engine is not in neutral, you need to retract the side bracket and pinch the clutch handle, and press this button to start the engine.

**Attention**



- After a car wash or heavy rain, etc., use compressed air to blow out the stagnant water inside the switch to avoid abnormal function of the switch.



## Ignition switch

When the key is in the  position, turn the direction handle to the far left, press the key inward, rotate counterclockwise to  and pull out the key; To unlock the lock, simply turn the key clockwise.



Position	Function	Remark
	Use when parking (vehicle power off)	The key can be removed
	Use when starting or driving	The key cannot be removed

### 警告 Warning

- When parking (including long stops), the ignition switch must be placed in the "" or "PUSH" position to ensure vehicle safety and prevent battery "battery loss".
- Do not push the motorcycle with the steering mechanism locked, otherwise it will lose its balance.

## Start the engine

Whether the engine is hot or cold, follow the instructions below to start the engine.



1. Rotate the ignition to the "Ⓞ" (on) position.
2. Switch gear to neutral (N neutral indicator lights up).
3. Pull the button down and hold it until the engine starts.

If the engine does not start:

If the engine does not start within 3 seconds, wait 10 seconds before repeating step 3.

### Attention

- Prolonged high-speed idling and idling can damage the engine and exhaust system.
- Jerking the throttle or idling at high speed for more than 5 minutes may cause discoloration of the exhaust pipe.
- If the throttle is fully open, the engine will not start.

## Shift gears

Your motorcycle has 6 forward gears with a shift mode on 1 under 5.

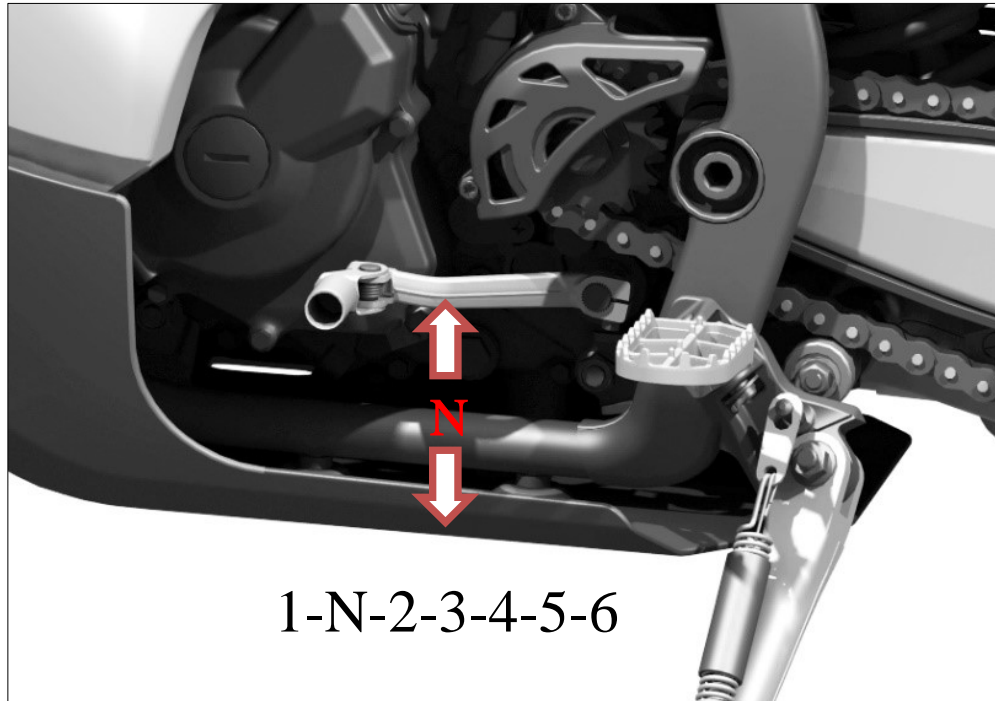

### Way to change gears:

Warm up the engine to keep it running normally.

1. When the engine is idling, disengage the clutch and press the gear shift pedal down so that the transmission enters the low gear (first gear) position.

2. Gradually increase the engine speed, slowly release the clutch handle, these two actions coordinate and cooperate to ensure a natural start.

3. When the motorcycle reaches a balanced driving state, reduce the engine speed and then disengage the clutch, hook the gear pedal upwards into the second gear, and so on, and the rest of the gear changes can be carried out in the same way.

### Things you should pay attention to while driving:

1. Avoid unnecessary engine idling, and do not allow the engine to idle at high speed, otherwise it will seriously damage the parts.
2. The clutch is driven in a semi-disengaged state, which will make the clutch plate wear out quickly.
3. If you feel that the engine horsepower is insufficient when climbing, you should switch to low gear in time.
4. In driving, especially downhill and high-speed driving, it is not allowed to use the front brake alone or neutral coasting, and it is not allowed to drive without the handle.
5. When parking, retract a small throttle while cutting off the clutch and then braking.

## Refueling

Your motorcycle is equipped with 2 fuel tanks, one on the left and right sides of the motorcycle body, with a total capacity of 14 liters, and each fuel needs to be added. Unleaded gasoline of 92# or above is recommended.

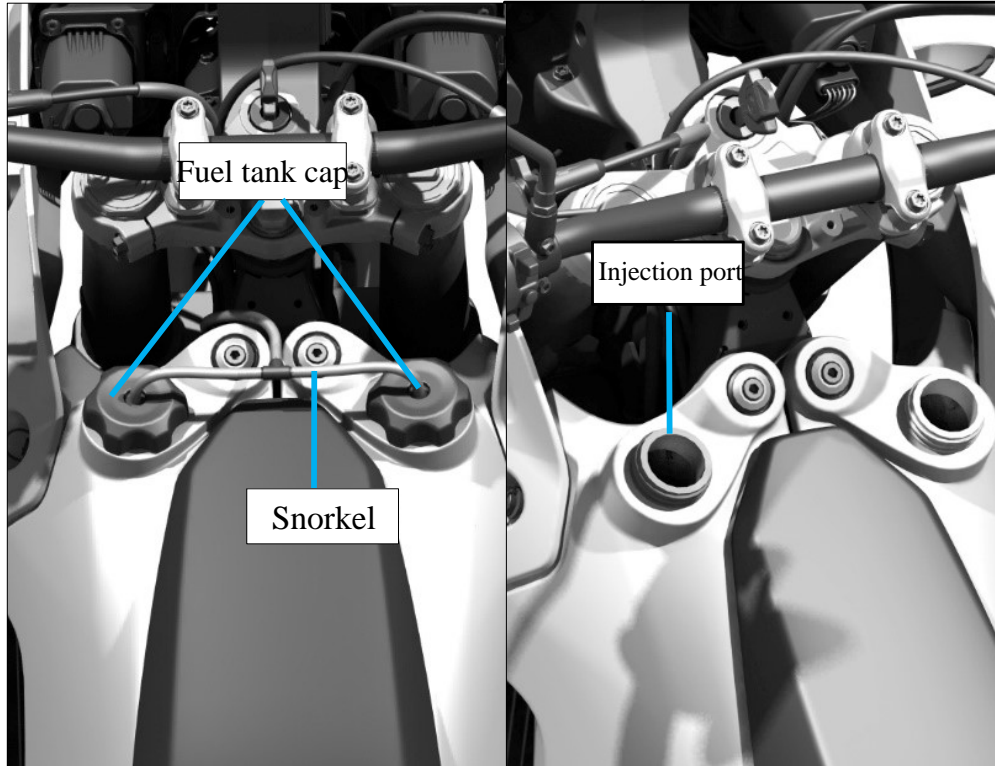

**Open the tank cap:** rotate counterclockwise.

**Close the tank cap:** turn and tighten the tank cap clockwise, so that the snorkel cannot be twisted during the tightening process.

### When filling fuel:

After stopping using the side bracket, open the fuel tank cap for filling, and after injecting fuel, close the fuel cap.

Avoid overfilling the fuel, pay attention to the change of oil level during the addition process, and it is recommended that the addition amount should not exceed 90% of the total capacity of the tank (to avoid the expansion of fuel due to heating).

**警告** Warning

- When refueling, please do it outdoors, be sure to turn off the engine, keep away from heat, sparks or open flames, and wipe clean immediately if splashed.

# Maintenance

Please read the "Maintenance" and "Maintenance Specifications" carefully before preparing for maintenance. For maintenance data, please refer to "Technical Parameters".

Maintenance .....	29
Maintenance cycle .....	30
table	
Maintenance .....	31
specifications	
Replace parts .....	32
Disassembly and installation of .....	40
body components	
Engine oil and oil concentrate filters .....	42
Oil and gas separator .....	44
Coolant .....	45
Brake .....	46
Side brackets .....	48
Drive chain .....	49
Clutch .....	51
Throttle .....	52
Front shock adjustment .....	53
Rear shock .....	56
adjustment	
Headlight .....	61

## Maintenance

### The importance of maintenance

It's important to keep your motorcycle in good service condition, which is essential for your safety, as well as protecting your property, getting the best performance, preventing breakdowns and mitigating air pollution.

Maintenance is an important responsibility of motorcycle owners, ensuring that inspections are carried out before each ride and that regular inspections are carried out as described in the maintenance cycle table.

### Follow these guidelines for maintenance:

- Turn off the engine and remove the key.
- Park the motorcycle on a firm and flat ground with a side bracket or support it with a maintenance bracket.
- Please wait for the engine, muffler, brake, and other hot parts to cool down before starting operation, otherwise it may cause burns.
- Please start the engine under specified circumstances and in a well-ventilated environment.

### Safety of maintenance

Read the service instructions before each service to ensure you have the necessary tools, parts and skills. We cannot alert you to every hazard that may arise during maintenance. Only you can decide if you should have maintenance or repairs done.



### Warning

- Failure to perform proper maintenance prior to riding or to properly remove malfunctions may result in serious injury or fatal accidents.
- Follow the inspection, maintenance recommendations and maintenance cycle table provided in the instruction manual.

## Maintenance cycle table

The vehicle should be maintained within the specified time, and for safety, it should only be serviced by the Kove special repair shop.

The symbols in the table have the following meanings:

I: Inspection, cleaning, adjustment R: replacement A: adjustment L: lubrication

No. Maintenance Items of Maintenance		Project period	Mileage table km( note 2)				
			1000km/3M	4000km/6M	8000km/6M	12000km/6M	
*	Fuel system oil circuit			I	I	I	*The item is repaired by the personnel of the maintenance station. If the user has special tools, repair parts and repair ability, he can also repair it by himself, and the repair knowledge can refer to instruction manual  **To ensure safety, the project can only be carried out by KOVE  Note: 1. When driving in dusty areas, such as deserts or grounds, the air filter element needs to be replaced or cleaned daily. 2. When the odometer reading exceeds the given maximum figure, its maintenance interval is still repeated according to the mileage interval specified in the table. 3. Motorcycles often used in harsh conditions should be reduced by 50% of the motorcycle maintenance interval
*	Fuel Filter					R	
*	Throttle operating system		I	I	I	I	
	Air filter cartridge		1000km or 1M for replacement, daily replacement for venue or desert rides				
*	Spark plug		I	I	I	I	
	Exhaust valve clearance		I	I	I	I	
	Intake valve clearance		I	Check, clean and adjust every 2000km afterwards			
*	Engine oil		Change the engine oil at 500km, 1500km and every 4000km thereafter				
*	Oil Filter		Change the oil filter together with the oil change				
*	Timing Chain Tension		A	A	A	A	
	EFI system			I	I	I	
	Drive Chain			I、L	I、L	I、L	
	Battery	Every month	I	I		I	
	Brake disc wearing			I	I	I	
**	Brake system		I	I	I	I	
*	Headlight dimming		I	I	I	I	
*	Clutch		I	I	I	I	
**	Fastener			I	I	I	
**	Directional bearings		I	I	I	I	

Service Outlets:  
(Official seal of the unit)

Service Personnel: \_\_\_\_\_

User Signature: \_\_\_\_\_

Date: \_\_\_\_\_

## Maintenance specifications

To ensure safety, it is your responsibility to conduct a pre-ride inspection and ensure that any problems you find have been corrected. A pre-ride check is required.

Items	Content
Handlebar	Flexible rotation, no play and loosening
Brake system	Check its health, check the front and rear brake fluid levels and the amount of brake pad wear
Fuel level	Sufficient fuel storage for the planned distance (refueling if necessary)
Throttle	Check that it opens smoothly and closes completely in each steering position
Clutch	Check its health and, if necessary, adjust the free itinerary
Wheels and tires	Check its condition of use and tire pressure, and replenish air pressure if necessary
Drive chain	Check its condition and sag status, adjust and lubricate if necessary
Lighting, horns	Check whether the lighting system and horn performance is good
Oil level	If necessary, add engine oil and check for leaks
Instrument indication	Check whether the indicators on the meter are displayed normally



## Replace parts

### Battery

#### Check and replace the battery

1. Before battery installation, if the electrode is found to be dirty, please wipe it clean before installing, otherwise it may cause functional failure due to poor contact.
2. If the battery is deformed, abnormally heated, smoked and other abnormal phenomena during use, please stop using it immediately and go to the Kove special maintenance shop in time for investigation.
3. If the battery is placed in a high temperature and humid environment for a long time, there may be functional failure, life shortening, etc., before using it again, please ensure that the appearance and function of the battery are normal before installation and use.
4. If the whole vehicle cannot be started, please check whether the battery is normal, if the battery is damaged, please replace it in time.

If the battery has not been used for a long time, please pay attention to the following situations:

In order to prevent the occurrence of over-discharge, the battery should be charged once every 2 months.

When the battery is not in use, it should be placed in a cool and dry environment and prevent short circuit of the positive and negative poles of the battery.

#### Attention

- Improper disposal of batteries may cause harm to the environment and human health, please dispose of disposed of batteries in accordance with local environmental protection regulations.
- Adding vehicle electrical appliances may cause battery loss and even cause electrical system failure.

**Fuse**

Fuses protect your motorcycle's circuitry, if some electrical parts on your motorcycle stop running, check and replace the blown fuse.

**Check and replace the fuse**

Turn the ignition to " " (off) position, remove and check the fuse. If the fuse blows, replace it with a fuse of the same size. For fuse specifications, please refer to "Technical Parameters".

If the fuse is often blown out, there may be hidden problems in the electrical appliance, please leave it to Kove Special Maintenance Shop for repair.

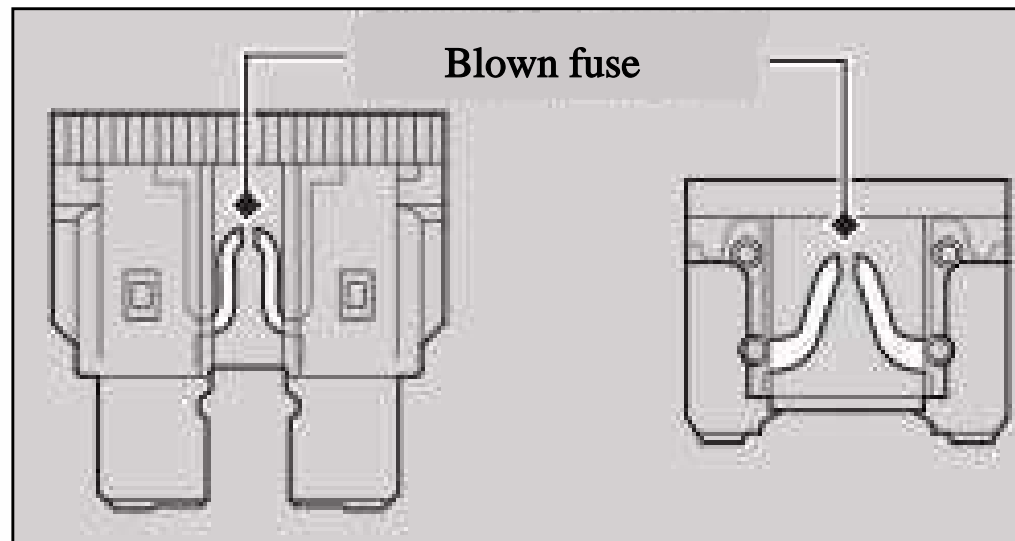

**Attention**

- Fuses need to be replaced in equal amounts, if you replace a higher rated fuse will increase the chance of damaging the electrical system and risk burning the car.
- Installing non-Kove electrical fittings can overload the electrical system, cause the battery to discharge, and even damage the system.

## Engine oil

The consumption of engine oil and the drop in oil quality will vary depending on the riding conditions and use time, the higher the operating speed, the faster the oil consumption rate, long-term high-speed or high-speed operation, should shorten the oil change interval, check the engine oil level frequently, if necessary, add the recommended engine oil.

When used in extreme temperatures, the oil quality drops faster, and the oil that has become dirty or has been used for a long time should be replaced as soon as possible.

### ■ Select engine oil

The oil should be SN grade of API classification, and its grade is SN10W-40.

## Brake fluid

Do not add or replace brake fluid except in an emergency. Use only brake fluid freshly removed from the sealed container, and if you add brake fluid, have the brake system checked by a Kove repair shop as soon as possible.

## Coolant

Only the original undiluted Kove pre-mixed coolant can be used, the original Kove pre-mixed coolant can be excellent in preventing corrosion and overheating, please pay attention to the coolant capacity, if the liquid level is lower than the lower limit, please add it in time. Coolant freezing point -38 °C, boiling point 125 °C.

#### Attention

- Brake fluid can damage plastic and paint surfaces, so wipe it off immediately and wash it thoroughly.
- Recommended brake fluid: DOT4 brake fluid or equivalent.
- The use of coolant dedicated to non-aluminum engines, ordinary tap water or mineral water can cause corrosion.

## Drive chain

The drive chain must be checked and lubricated regularly. If you are constantly driving in poor road conditions, driving at high speeds, or repeatedly increasing speed, you need to check the chain more often.

If the drive chain does not run smoothly, makes abnormal noises, has damaged rollers or loose latches, or the oil seal is missing or bent, please refer the chain to Kove Service Shop for inspection.

Also check the active sprocket and driven sprocket, if any of them have worn or damaged teeth, please take it to the Kove repair shop for replacement.



### Attention

- Using a new drive chain on a worn sprocket will accelerate chain wear, and both the drive chain and sprocket should be replaced at the same time.
- Recommended lubricant: chain oil seal special lubricant SAE80 or 90 gear oil.

## I Clean and lubricate

After checking the sagging, turn the rear wheel while cleaning the chain and sprocket, you can use a dry cloth, special cleaner for the oil seal chain or neutral detergent, if the chain is dirty, you can use a soft brush; After cleaning, wipe dry and lubricate with the recommended oil.

Do not use steam cleaners, high-pressure cleaners, wire brushes, volatile solvents such as gasoline and benzene, scrubs, chain cleaners and lubricating oils that are not dedicated to oil seal chains, otherwise the chain oil seal may be damaged.

Avoid getting oil on the brakes or tires, and avoid using excessive amounts of oil to avoid splashing on clothes or motorcycles.

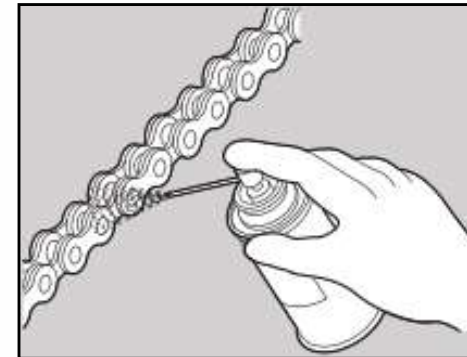

## Tires (inspection/replacement)

### ■ Check the specifications

Front Wheel: Tires: 90/90-21M/C 54R Tubes: 275/300-21 Belts: Liners 21×30mm

Rear Wheels: Tires: 140/80-18M/C 70R Tubes: 450/475/510-18 Belts: Liners 18×30mm

### ■ Abnormal wear check

Check the contact surfaces of the tires for signs of abnormal wear.

### ■ Check the depth of the tread

Check the tread wear indicator and replace the tire immediately if the wear reaches the indicator mark.

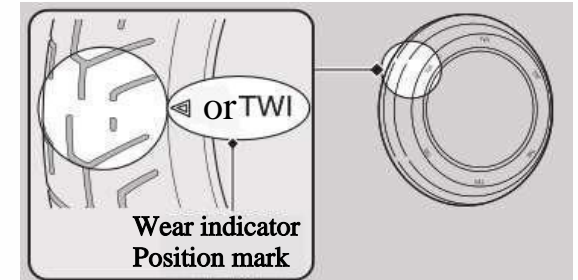

### ■ Check your tire pressure

When you feel that the tire pressure is low, visually inspect the tire and measure it with a barometer, check the tire pressure while the tire is cool, and check the tire pressure at least once a month. Make sure the valve core cap is fastened and, if necessary, replace it with a new one.

### ■ Injury examination

Inspect the tire for cuts, cracks, exposed fabric, tire threads, nails or other foreign objects embedded in the side tread of the tire, and check the sidewall of the tire for any abnormal bulges or swelling.

Whenever you change your tyres, follow these guidelines:

- Use recommended tires or equivalent products with the same size, construction, speed class and load capacity.
- After the tires are installed, use the original balance positioner or equivalent equipment of Kove to balance and position the wheels.
- When changing tires, be sure to replace the inner tube, the old inner tube may have been deformed and if it is installed on a new tyre, it will also cause cracking.

 **警告** Warning

- Using over-worn or improperly inflated tires can lead to accidents and serious injuries, please follow the relevant tire maintenance guidelines in the instruction manual.
- Installing unsuitable tires can affect handling and stability and lead to accidents that can seriously injure you or even endanger your life.
- Always use the size and type of tires recommended in this instruction manual.

**Air filter**

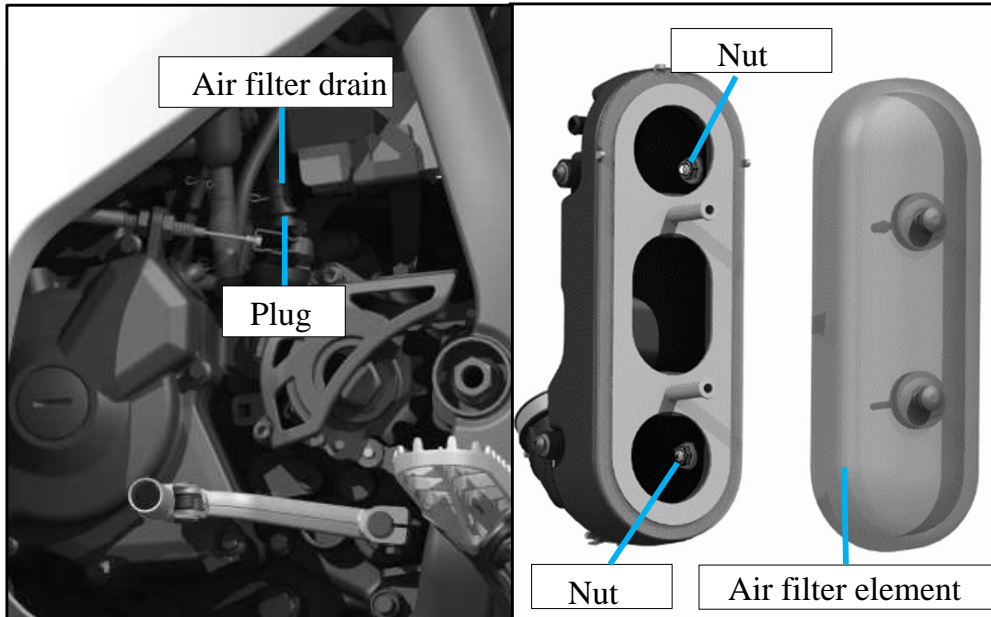

The air filter drain pipe is located at the lower end of the air filter, every 3 months need to check whether there is water or oil in the drain pipe, if you clean the motorcycle or heavy rain should be checked in time, if there is, remove the plug under the air filter drain pipe for discharge, and then install the plug after the drain.

This motorcycle is equipped with an air filter made of sponge, please do not maintain it yourself, and should be cleaned or replaced by Kove repair shop.

If you ride in dusty road conditions, the air filter should be cleaned or replaced every 3 days according to the actual situation, and the desert environment needs to be cleaned or replaced every day.

**Attention**

- After disassembling and assembling the air filter, check whether the 4 nuts inside are loose, and the bolt nuts must be tightened.

## Tool

You can use the on-board tool for simple repairs, minor adjustments, and parts replacement.

- Double-ended screwdriver
- Double head wrench 8×10
- Double head wrench 12×14
- Allen Key 5
- Allen Key 4
- Fishtail pliers



## Disassembly and installation of body components

### Battery

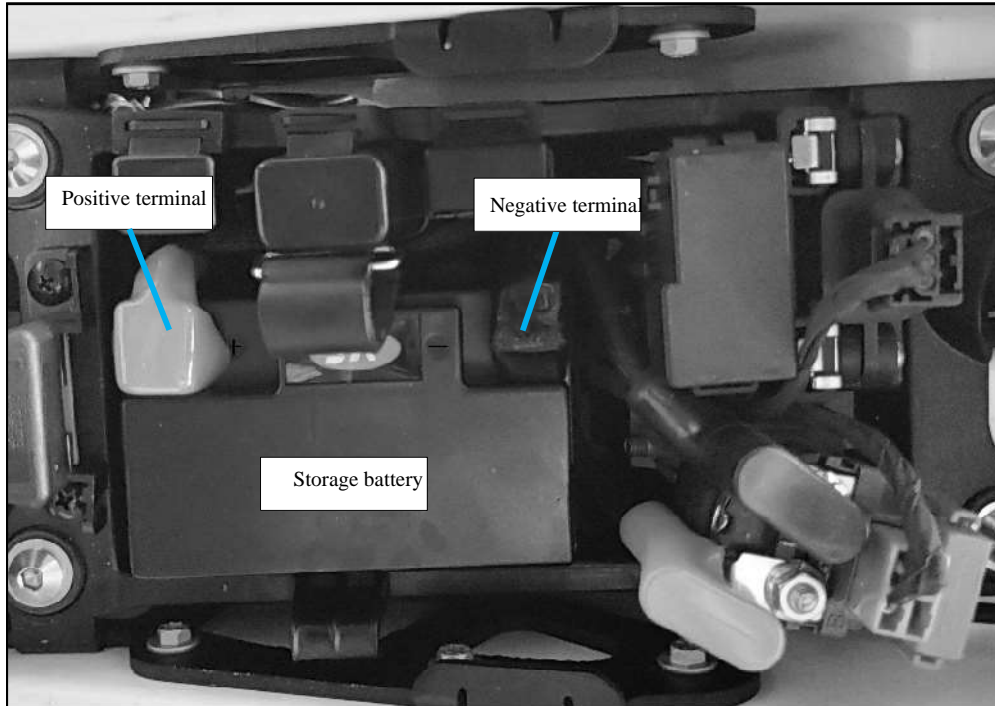

#### ■ Disassembly

Confirm that the ignition is turned to the "⊗" (off) position.

1. Remove the seat cushion.
2. Loosen the rubber band from the rear.
3. Disconnect the negative (-) terminal of the battery.
4. Disconnect the positive (+) terminal of the battery.
5. Remove the battery and be careful not to leave bolts and nuts behind.

#### ■ Installation

Install the parts in the reverse order of removal, always connecting the positive terminal first

(+) terminal, and finally the negative (-) terminal, make sure that the bolts and nuts are tightened.

**Cushion**

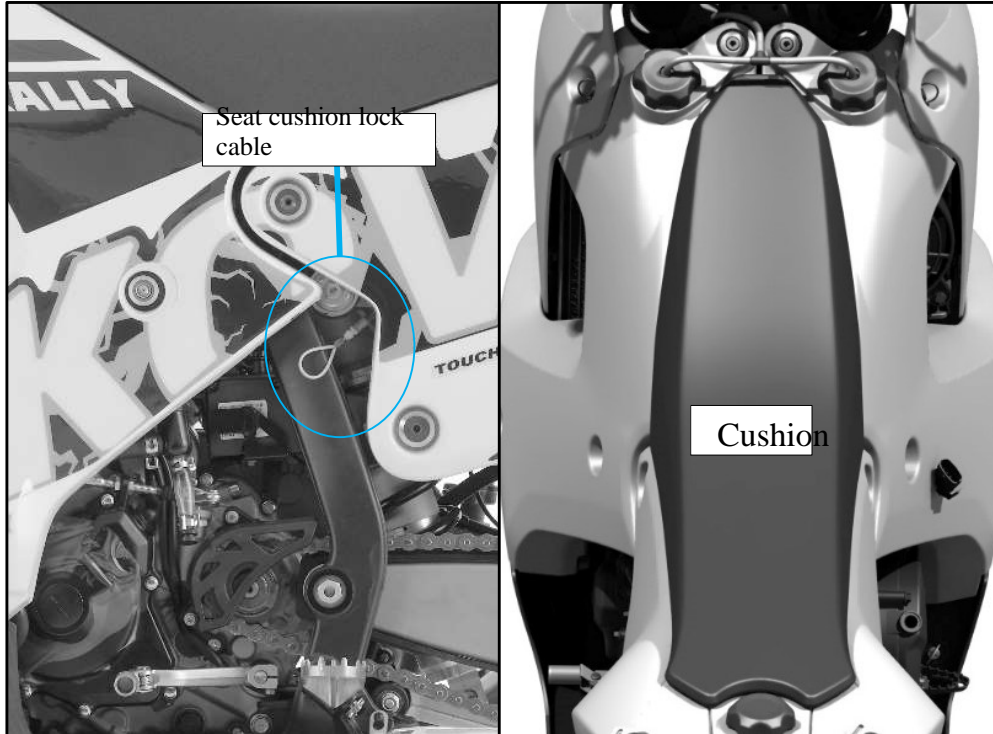

**Disassembly**

Pull the saddle latch down while pulling the rear end of the saddle up to disengage from the lock, then remove the saddle diagonally backwards.

**Installation**

1. Snap the front and rear latches of the seat cushion assembly into the frame card slots.
2. Align the seat cushion lock pin and lock hole, press down the back of the seat cushion, the lock pin is inserted into the seat cushion lock lock hole, and is automatically locked by the lock tongue. Gently pull up to ensure the seat cushion is securely locked in place.
3. When the seat cushion is closed, the seat cushion lock will lock automatically.

**Attention**

- Please ensure that the cushion latch is inserted accurately into the frame card slot, otherwise the saddle product will not be able to support your weight and the saddle product may be crushed.

## Engine oil and oil concentrate filters

### Replace the engine oil and oil concentrate filter

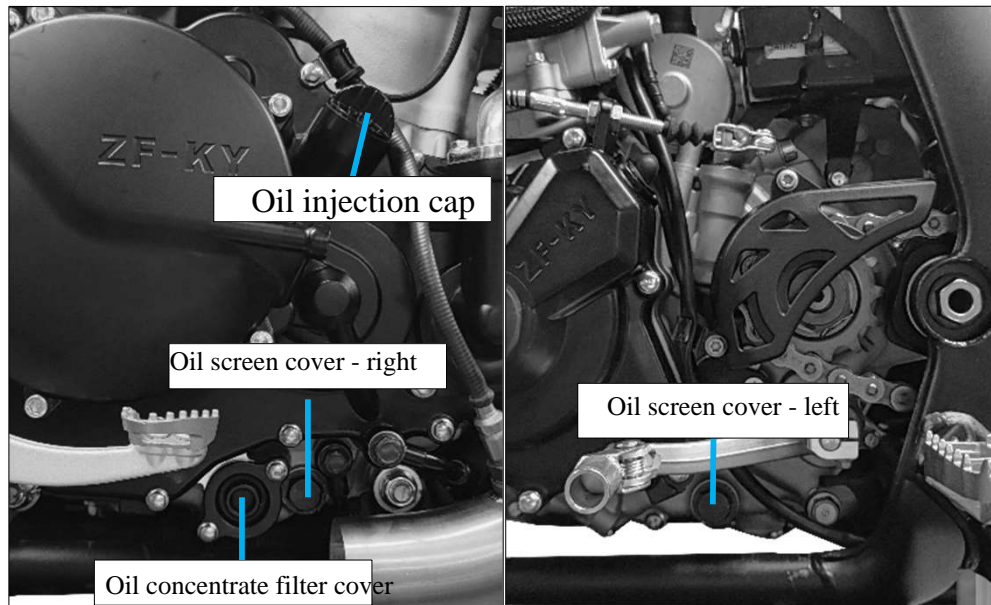

Changing engine oil and oil concentrate filters requires special tools,

which we recommend being done by Kove Service Shop. Please refer to the "Maintenance Cycle Table" for engine oil and oil concentrate filter maintenance intervals.

Use the original engine oil and oil concentrate filter of the special Kove specified for your model.

1. If the engine is cold, please idle for 3-5 minutes; Rotate the ignition to the  (off) position and wait another 2-3 minutes;

2. Park the motorcycle on a stable horizontal surface and place an oil drain tray under the oil drain bolt;
3. Remove the oil filter cover of the left and right boxes and take out the oil filter;
4. Remove the oil fine filter cover and spring, and take out the oil fine filter;
5. Remove the engine oil injection cap, oil drain bolt and sealing gasket, and remove the oil until the oil is droplet;
6. Replace a new oil fine filter, and then install the spring and oil fine filter cover in turn; (Torque: 11~13N·m)
7. Reinstall the cleaned oil filter into the left and right boxes and tighten the oil filter cover; (Torque: 11~13N·m)
8. Install a new sealing gasket on the oil drain bolt and tighten the oil drain bolt; (Torque: 24~27N· m)
9. Add the recommended original engine oil to the crankcase. After filling, tighten the oil injection port cap; (Torque: 4~6N·m)

**When replacing the oil fine filter, the amount of oil required: 1.6L**  
**When disassembling the engine and reassembling it, the amount of oil required: 1.8L**

10. Check whether the oil is leaking.

## Precautions for replacing engine oil and oil concentrate filter:

1. Using the wrong engine oil and oil concentrate filter can seriously damage the engine.
2. Excessive refueling or insufficient oil will damage the engine, do not mix different brands and grades of oil, which will affect lubrication and clutch operation.
3. When changing the oil, it is necessary to replace the new oil fine filter and clean the left and right oil filter.
4. When installing the oil fine filter, it should be noted that the opening end of the oil fine filter should face the left body.
5. Long-term contact with engine oil should be avoided, and it should be thoroughly washed after contact with engine oil.
6. Used oil, oil concentrate filter and container are harmful to health and the environment, can not be treated as daily garbage, treatment methods should be in line with local environmental protection regulations.

## Oil strainer inspection and cleaning

The oil filter should be inspected and cleaned every 3000 kilometers, and if the oil filter is found to be damaged during the inspection, it should be replaced in time. The oil filter should also be cleaned each time the oil is changed.

1. Remove the oil filter cover of the left and right boxes;
2. Take out the oil filter with needle-nose pliers;
3. Wash it with clean gasoline until the oil filter is washed clean;
4. Reload the clean oil filter into the box;
5. Install the oil filter cover. (Torque: 11~13N·m)

## Oil and gas separator

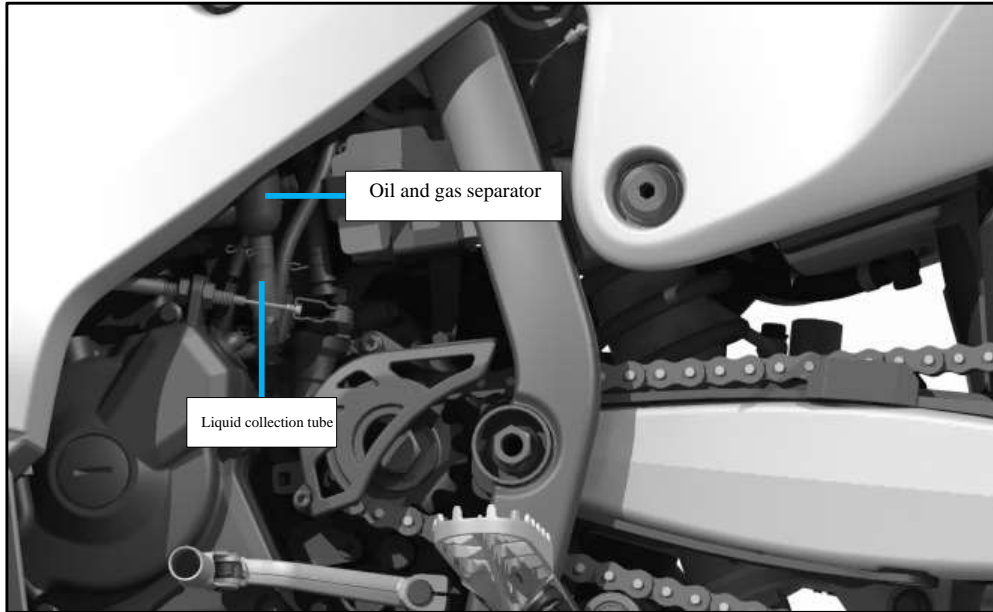

During daily maintenance, check the liquid collection tube, if there is fluid accumulation in the collection tube, it needs to be discharged in time.

Remove the plug under the collection tube, let it sit for a while, drain the oil or water, and then install the plug.

## Coolant

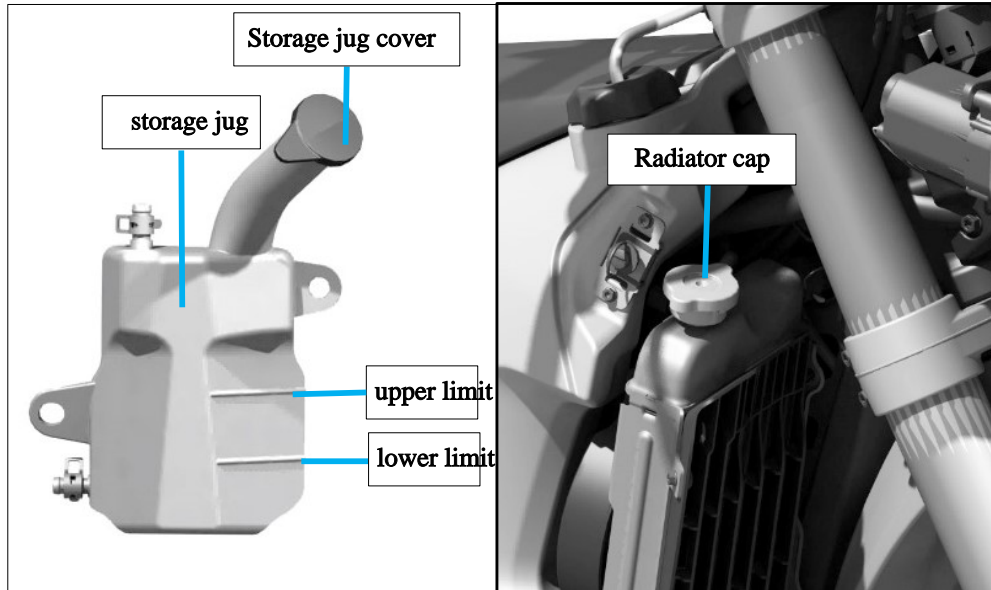

### Warning

- Do not remove the radiator cap when the engine is not cooling, as this will cause cooling. The liquid sprays out, which may cause you burns.
- Always wait for the engine and radiator to cool down before removing the radiator cap.

### Check the coolant

While the engine is cooling, check the coolant level in the jug.

1. Park the motorcycle on a stable level and keep the motorcycle upright.
2. Check that the coolant level is between the upper and lower limit level marks.
3. If the liquid level drops significantly or the storage tank is empty, serious leakage may occur, please hand over to Kove Special Maintenance Shop to overhaul the motorcycle.

### Add coolant

If the coolant level falls below the lower limit mark, add the recommended coolant until the level reaches the upper limit mark. When adding coolant, only from the lid of the water storage jug. Add coolant.

1. Remove the lid of the storage jug, add coolant and pay attention to the coolant level.

- Do not exceed the upper limit.
- Make sure no foreign objects enter.

2. Reinstall the cover.

### Change the coolant

Unless you have the right tools and qualified mechanical skills, leave the coolant to a Kove Service Shop.

## Brake

### Check the brake fluid

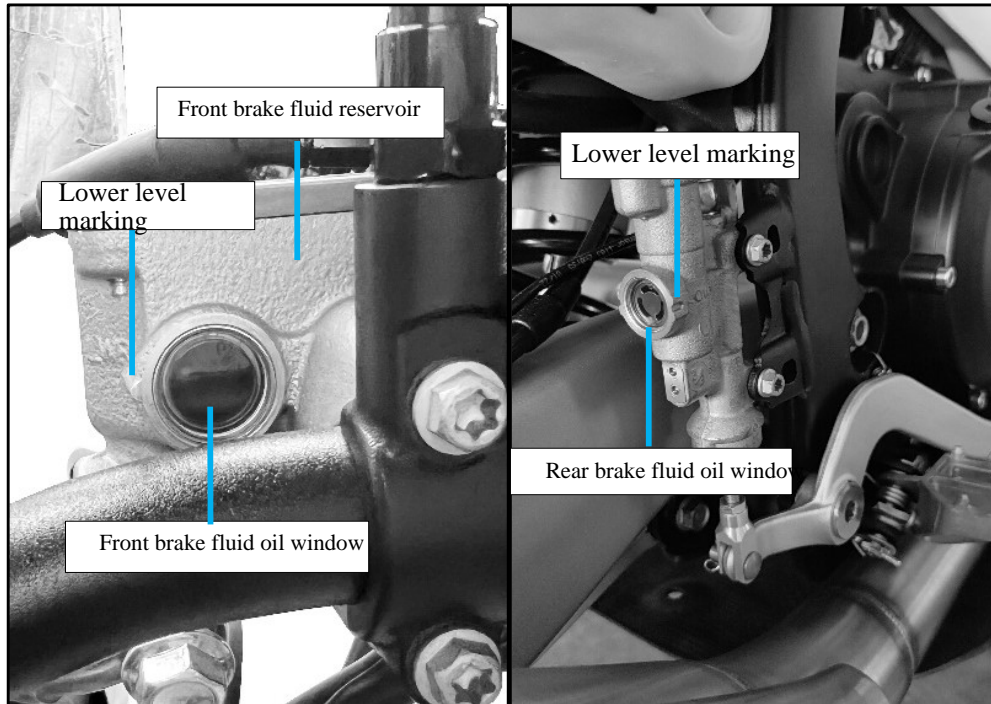

1. Place the motorcycle vertically upwards on stable flat ground.
2. Check whether the brake fluid storage tank is level.
3. Check whether the brake fluid can be seen in the oil window, if the brake fluid is lower than the lower limit of the oil window, please add it immediately.

If the brake fluid level in the reservoir is below the lower level mark (LWR),  
 Or the free travel of the brake lever and pedal exceeds the standard, it is necessary to check whether the brake pad is worn, if the brake pad is not worn, there may be leakage, please hand it over to Kove Special  
 Make an appointment with a repair shop for maintenance.

## Check the brake pads

Check the condition of the brake pad wear indicator mark, if the brake pad is worn to the indicator mark, it needs to be replaced.

**Front**

Check the brake pads from under the calipers  
Brake pad lining thickness: 4mm (indicated as wear limit)

**Rear**

Check the brake pads from the right rear of the caliper  
Brake pad lining thickness: 4mm (indicated as wear limit)

If necessary, please take the brake pads to the Kove Special Service Shop to replace the brake pads, when the wear limit is reached, the left and right brake pads must be replaced at the same time.

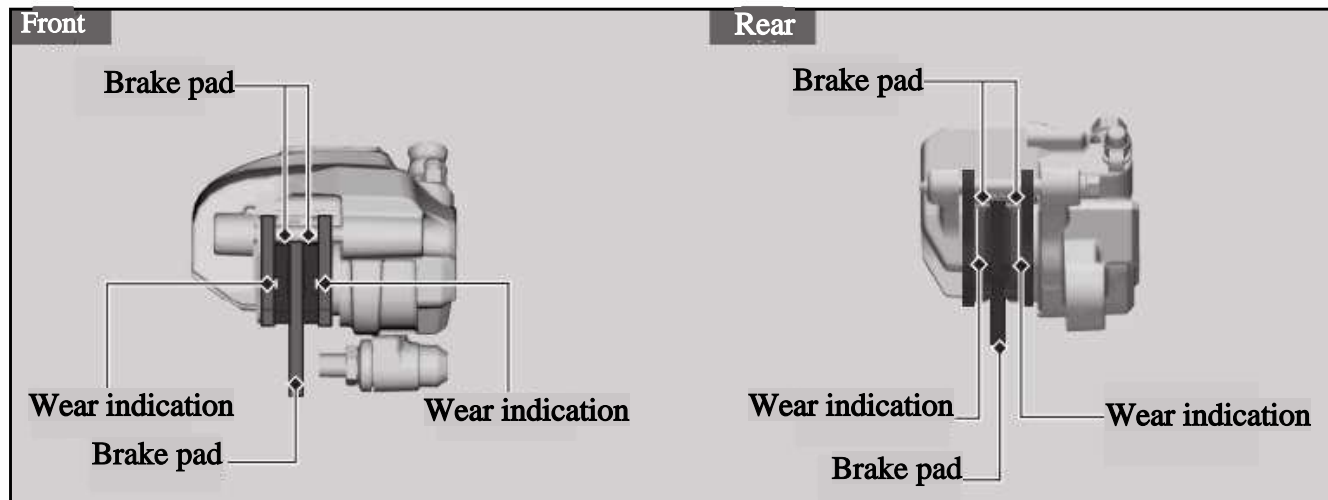



## Side bracket

## Check the side bracket

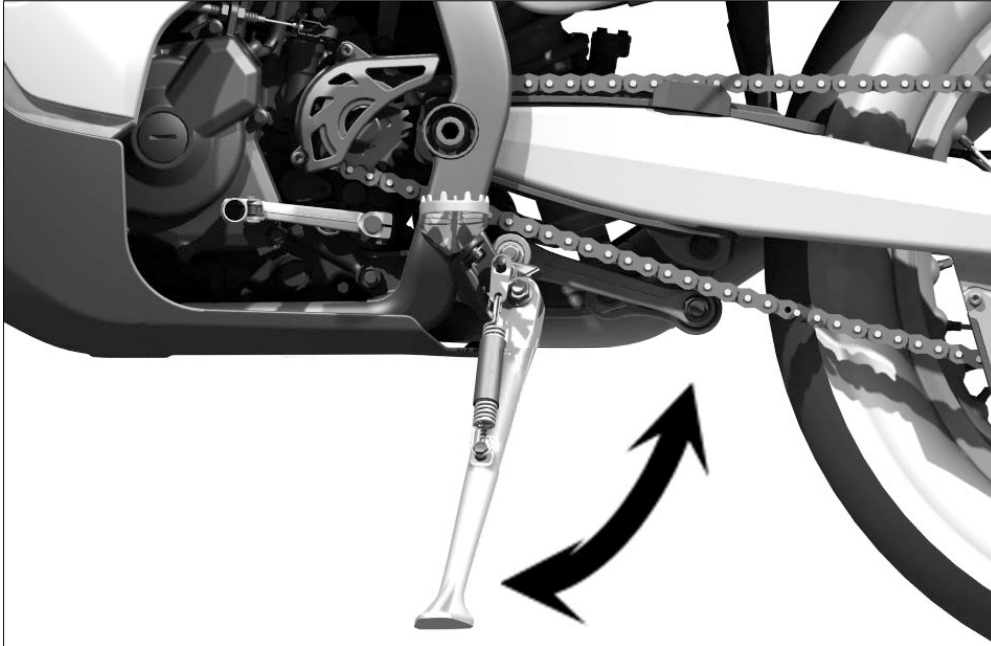

1. Check whether the side bracket operates freely, if the side bracket operation is stuck or makes a "squeaking" sound, clean the pivot area and lubricate the pivot bolt with clean grease.
2. Check whether the spring is damaged or loses its elasticity.

## Drive chain

### Check the sag of the drive chain

Check the sag of different points along the chain, if not all points have the same sagging, some links may have been bent and kinked, please leave the chain to the Kove repair shop.

1. Hook the transmission into neutral and turn off the engine.
2. Place the motorcycle vertically on a stable and flat ground.
3. In the area behind the chain guard, push the chain in the direction close to the flat fork to determine the sag of the chain.
4. Turn the rear wheel forward to check whether the chain runs smoothly.
5. Check the sprocket.
6. Clean and lubricate the drive chain.

Drive chain sagging: 30-55mm

If the sag exceeds 55mm, you cannot continue to ride the motorcycle.

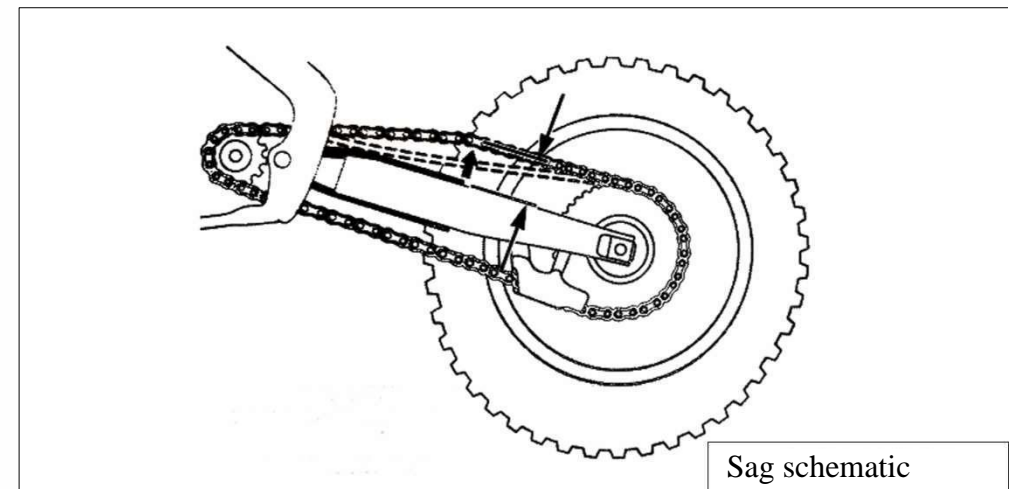

#### Attention

- When checking the drape of the drive chain, make sure that the upper part of the chain must be tensioned.

**Adjust the sag of the drive chain**

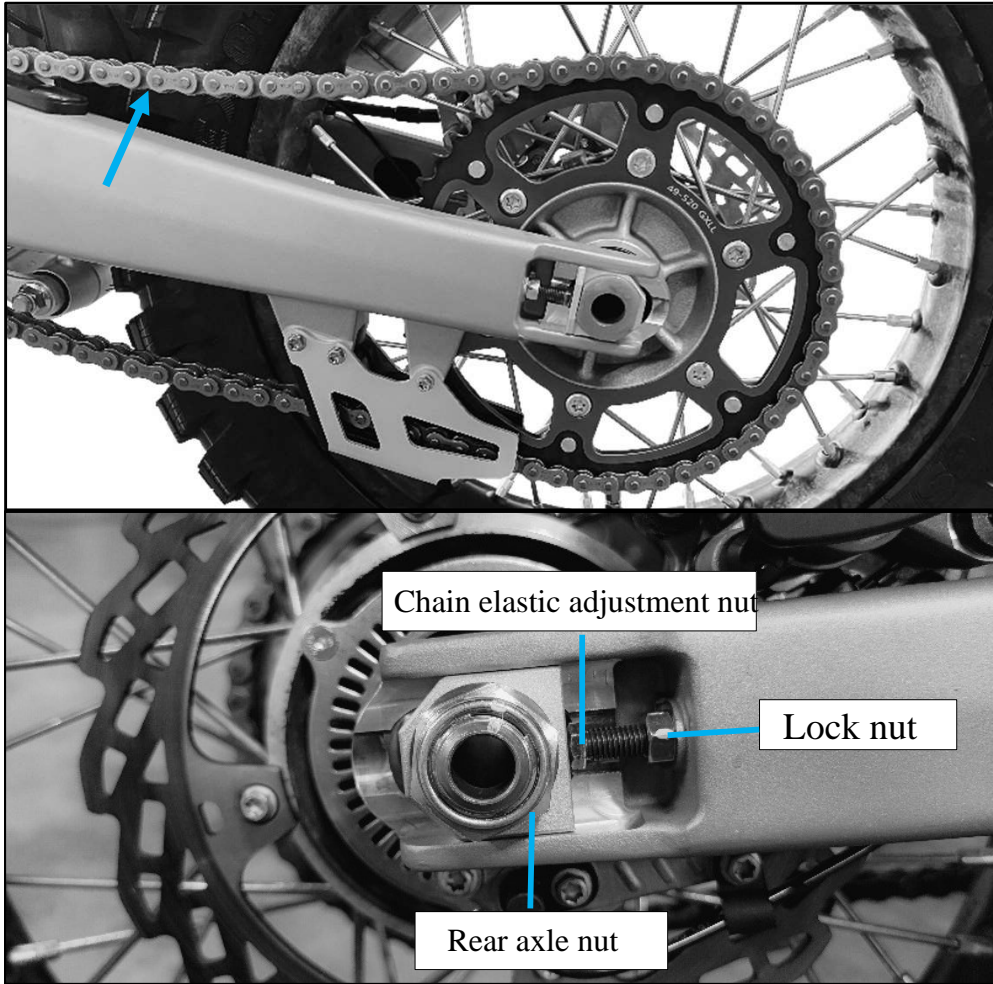

Chain tightness: 30-55mm

**Attention**

- When adjusting the drive chain sagg, make sure that the upper part of the chain must be tensioned.

When adjusting the drive chain sagging:

1. Hook the transmission into neutral and turn off the engine.
2. Place the motorcycle vertically on a stable and flat ground.
3. Loosen the rear axle nut.
4. Use an open wrench to loosen the lock nut and chain tightening adjustment nut.
5. Rotate the chain tightness adjustment nut to adjust the tightness of the chain, the chain tightness adjustment range is: 30-55mm.
6. In the middle position of the upper part of the rear flat fork, push the chain in the direction of the flat fork to determine the reasonable sag of the chain.
7. The left and right sides of the sag are adjusted on the same tick line.

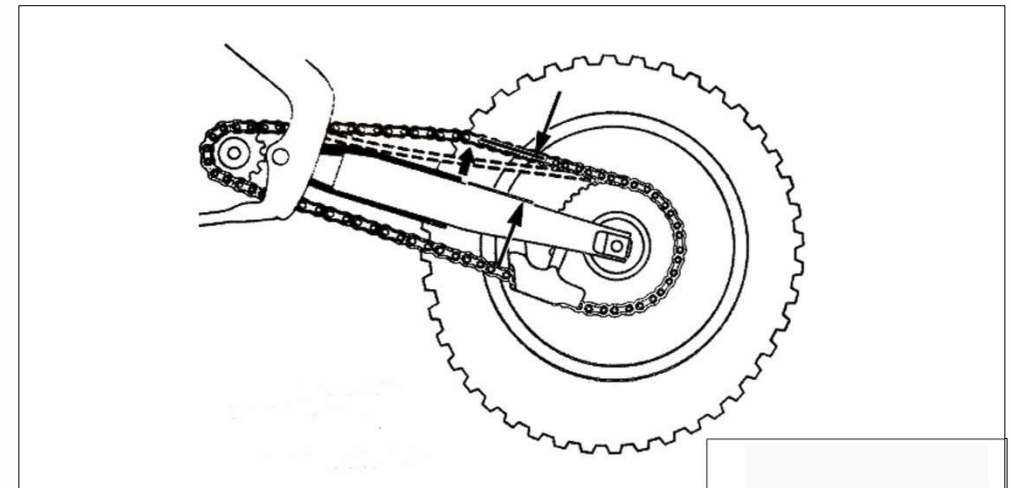

Schematic diagram of tightness

## Clutch

Free travel of clutch lever: 10-15mm

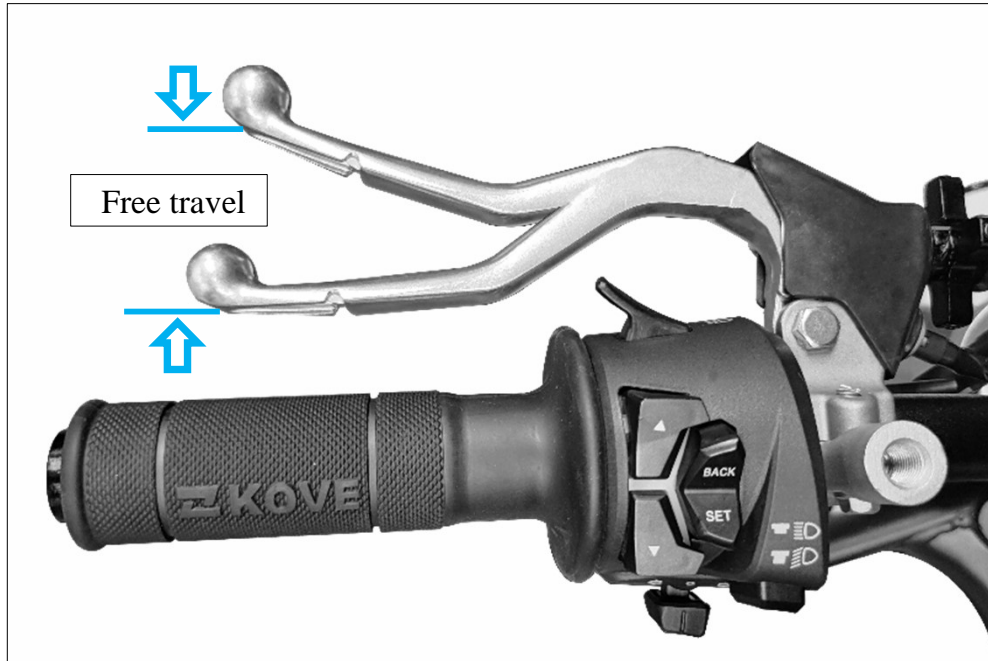

Check whether the clutch cable is bent or broken. If necessary, please leave it to Kove repair shop for replacement.

Please lubricate the clutch cable with a special cable oil to prevent premature wear and corrosion.

**Attention**

- Incorrect adjustment of free travel can cause premature clutch wear.

**Throttle**

**Check the throttle**

When the engine is off, check that the throttle smoothly shifts from full off to full open in all directions and that the free stroke is correct.

If the throttle operation is not smooth, the automatic closing or the cable is broken, please refer it to the Kove special repair shop for maintenance.

**Free travel of throttle handle flange: 2-6mm**

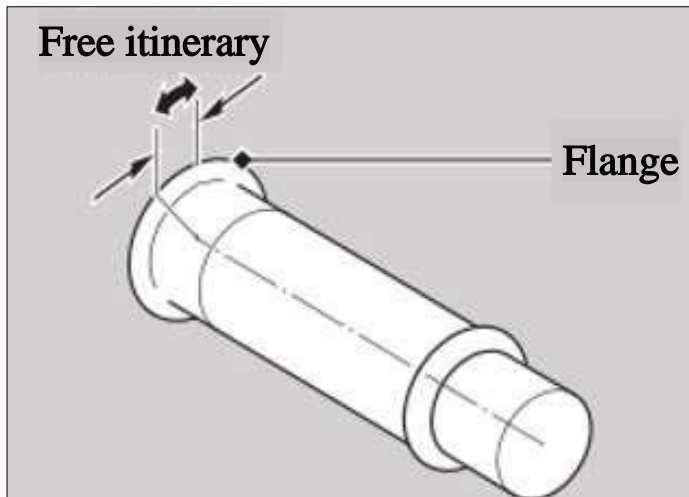

**Adjust the brake lever**

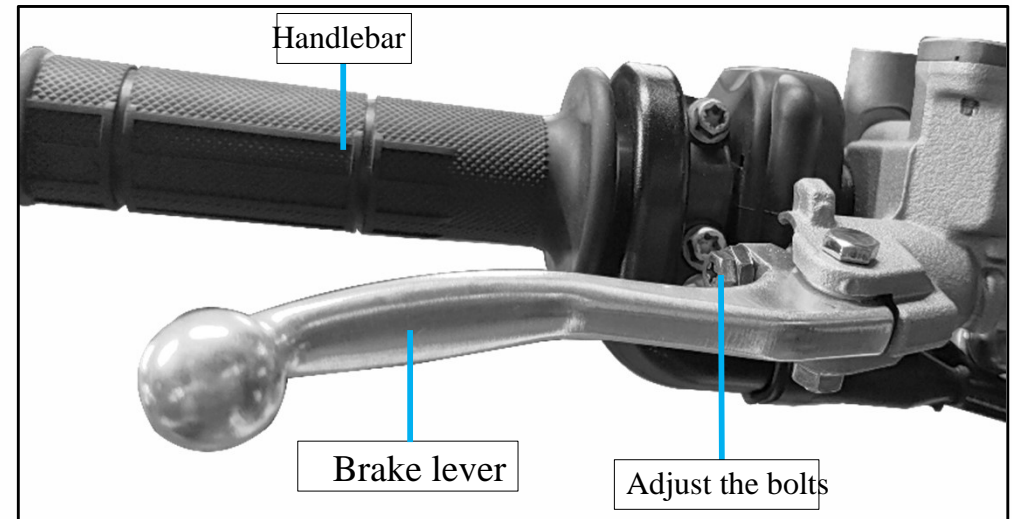

You can adjust the distance from the top of the brake lever to the handlebars.

**Methods of adjustment**

Rotate the adjusting bolt in a counterclockwise direction, and the brake handle is close to the handlebar; Rotate the adjusting bolt clockwise and keep the brake handle away from the handlebar.

The adjustment range is limited, do not screw the adjustment bolt beyond its natural limit.

Adjustments are not allowed while driving.

## Front shock absorber adjustment

### Air pressure adjustment

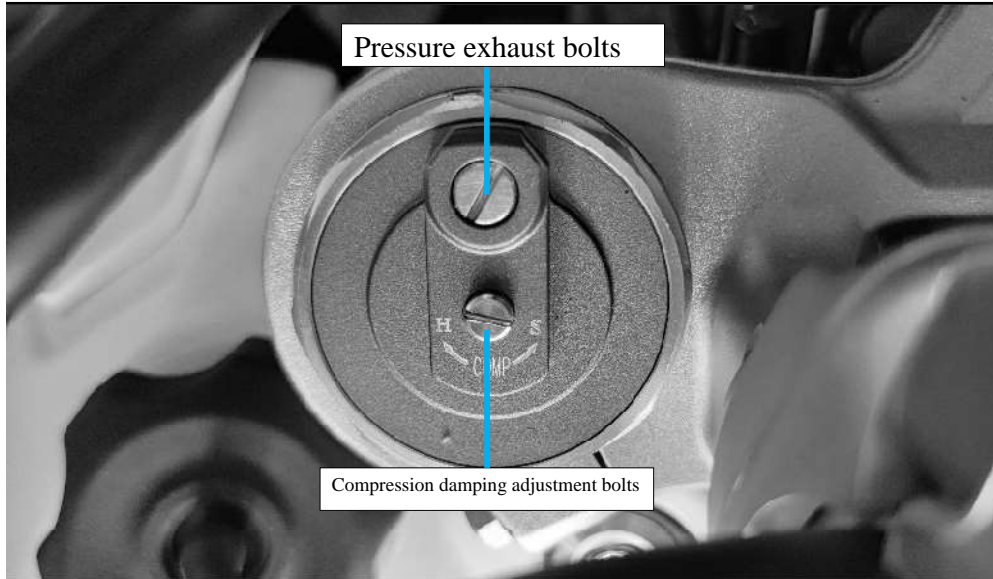

The shock absorber generates air pressure internally when it is worked, and the air pressure is like a progressive spring that affects the entire stroke of the motorcycle. On long rides, the front shock gets stiffer. Therefore, it is necessary to release the air pressure inside the front shock absorber in time.

You can use pressure exhaust bolts to release the air pressure that has built up inside the front shock absorber. Before releasing pressure, be sure to make sure that the front tires are off the ground, at which point the front shock absorbers are fully extended.

### Methods of adjustment :

1. Place an optional table under the engine to lift the front wheels off the ground.
2. Remove the pressure exhaust bolt.
3. Coat the O-ring with No. 2 lithium grease and install it.
4. Tighten the pressure exhaust bolt. (Torque: 1.3Nm)

### Attention

- When discharging the air pressure of the shock absorber before discharging, if the O-ring is broken, it should be replaced in time.
- The front wheel adjusts the air pressure on the ground, which gives the wrong degree of pressure.

## Compression damping adjustment

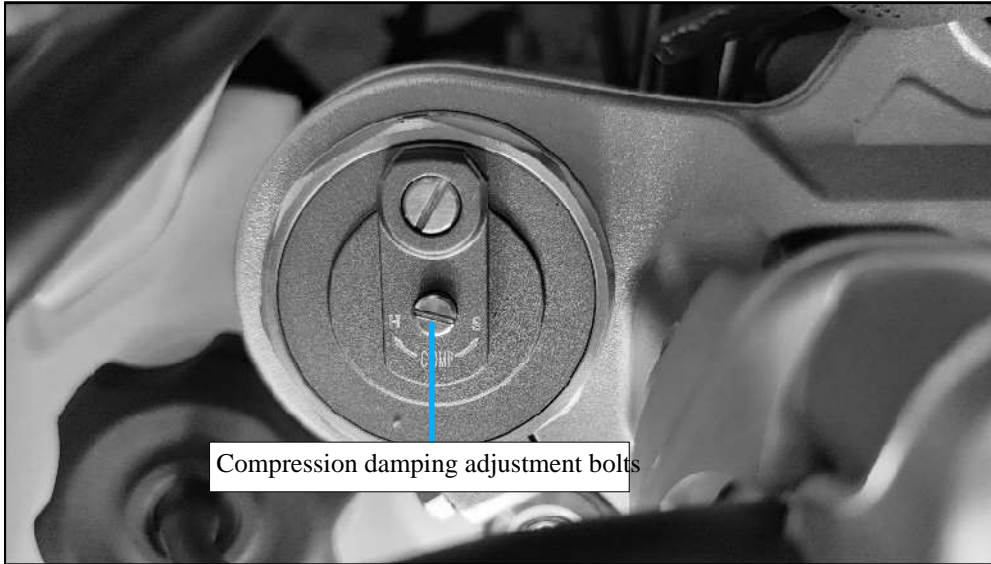

The adjustment of the compression damping affects the speed at which the front shock absorber compresses. The front shock absorber compression damping has 22 stages. Each segment is 1/4 turn. Turn the compression damping adjustment bolt for a full turn, and the adjuster will turn 4 segments.

Turn the adjusting bolt in the clockwise direction (H) to harden the compression damping, and turn the adjusting bolt in the counterclockwise direction (S) to become softer.

### Setting standard compression damping:

1. Turn the compression damping adjustment bolt clockwise until it no longer rotates;
2. Turn the adjusting bolt counterclockwise (lighter), the standard compression damping is rotated 10 segments from the hardest position, and a click is heard.

You can adjust it according to your weight and riding conditions, making sure that the adjustment bolts stop in the clicking position and the left and right ends are adjusted to the same position with each adjustment.

### Attention

- Do not rotate the adjusting bolt beyond the given position, otherwise you may damage the adjusting mechanism. The adjustment torque does not exceed 0.5Nm.

## Rebound damping adjustment

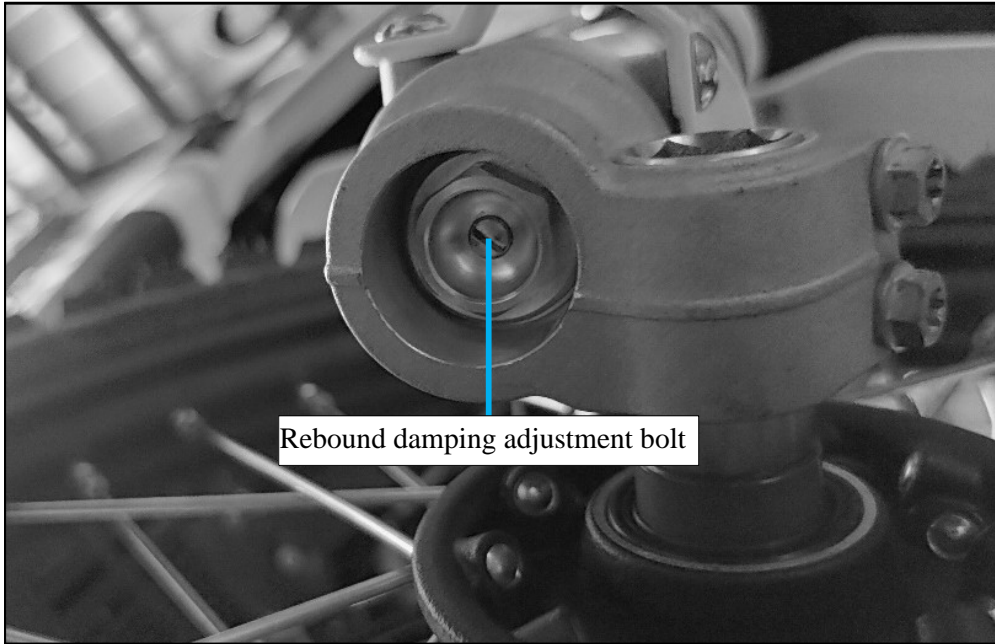

The adjustment of the rebound damping affects the speed at which the front shock absorber rebounds. The front shock absorber rebound damping has 22 stages. Each segment is 1/4 turn. Turn the rebound damping adjustment bolt for a full turn, and the adjuster will turn 4 segments.

**Attention**

- Do not rotate the adjusting bolt beyond the given position, otherwise you may damage the adjusting mechanism. The adjustment torque does not exceed 0.5Nm.
- Both compression damping and rebound damping can be increased by rotating the adjustment bolt clockwise.

Turn the adjusting bolt clockwise to increase the rebound damping (hard), and turn the adjusting bolt counterclockwise to reduce the rebound damping (soft).

Setting the standard rebound damping:

1. Turn the rebound damping adjustment bolt clockwise until it no longer rotates;
2. Turn the adjusting bolt counterclockwise (lighter), the standard rebound damping is 10 segments from the hardest position, and a click is heard.

You can adjust it according to your weight and riding conditions, making sure that the adjustment bolts stop in the clicking position and the left and right ends are adjusted to the same position with each adjustment.



## Rear shock adjustment

### Airbag

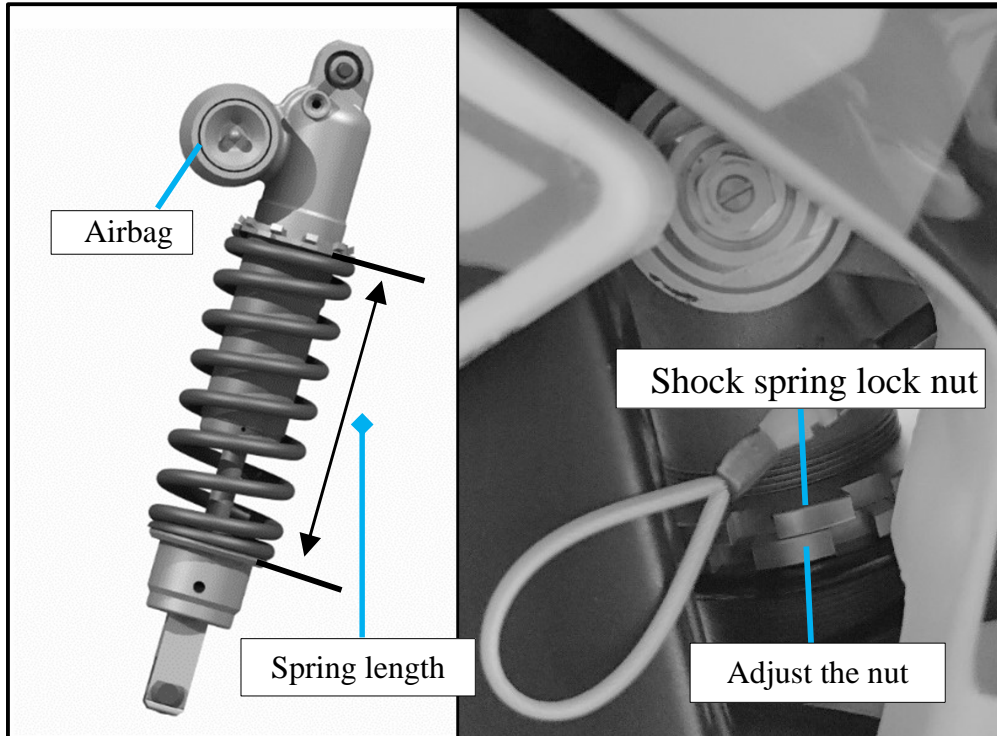

The rear damping assembly consists of a shock-absorbing airbag containing high-pressure nitrogen. Do not attempt to disassemble, repair or dispose of the device, piercing or exposure to flames may also result in an explosion causing serious injury. Repair or disposal should be done by Kove special repair shop.

### Spring preload adjustment

The spring preload should be adjusted when the engine is cooling, and the spring preload should be adjusted by turning the shock spring lock nut and adjustment nut.

Adjustment method:

1. Firmly support your motorcycle with a maintenance bracket or crane and lift the rear wheels off the ground.
2. Check whether the spring preload is at the standard length.
3. Loosen the shock absorber spring lock nut, rotate the adjustment nut, and the spring length will change by 1.5mm for each turn of the adjustment nut.
4. Adjust accordingly as needed.
5. After the adjustment is completed, hold the adjustment nut and tighten the shock spring lock nut.

( Torque:44N·m )

**High Seat Version:  
Increased spring preload:**

Loosen the shock absorber spring lock nut with a movable wrench, turn the adjusting nut, shorten the spring length, the shortest must not be less than: 215mm.

**Reduce spring preload:**

Use a movable wrench to loosen the shock spring lock nut, turn the adjustment nut, and increase the spring length, the longest is not higher: 230mm.

Each turn of adjusting the nut changes the spring length and spring preload.

**Low seat version:**

**Increased spring preload:**

Use a movable wrench to loosen the shock spring lock nut, turn the adjusting nut, shorten the spring length, the shortest must not be less than: 205mm.

**Reduced spring preload:**

Use a movable wrench to loosen the shock spring lock nut, turn the adjusting nut, increase the spring length, the maximum is not higher: 225mm. Each turn of adjusting the nut changes the spring length and spring preload.

## Compression damping adjustment

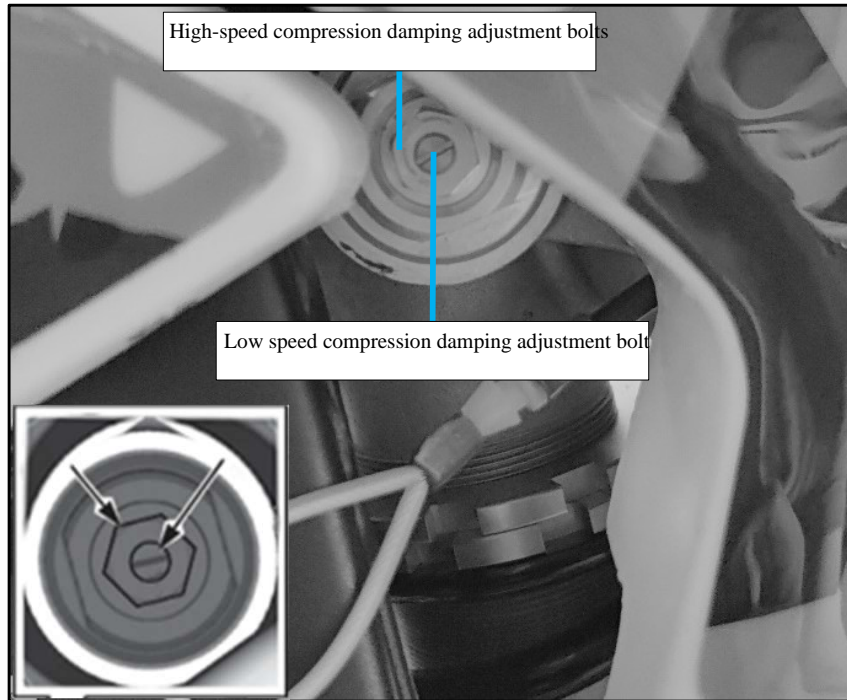

Compression damping can be adjusted separately for 2 stages of high-speed compression damping and low-speed compression damping, and you can adjust it accordingly according to your weight and riding conditions.

When adjusting the compression damping adjustment bolt, be sure to use a tool of the right size to avoid damage.

### High-speed compression damping adjustment

The high-speed compression damping adjustment bolt is effective when damping adjustment is required for high-speed operation, and the high-speed damping can be adjusted by turning the hexagonal part of the compression damping adjustment bolt, and the high-speed compression damping adjuster is adjusted incrementally at a speed of 1/4 revolution.

Make sure the high-speed compression adjuster is firmly in the brake position, not between positions.

Adjust to standard position:

1. Rotate the adjusting bolt clockwise (H) until it no longer turns the position (hardest).
2. Turn the adjusting bolt counterclockwise from the hardest position for 2 turns, and then turn  $\pm 1/4$  turn.

## Compression damping adjustment

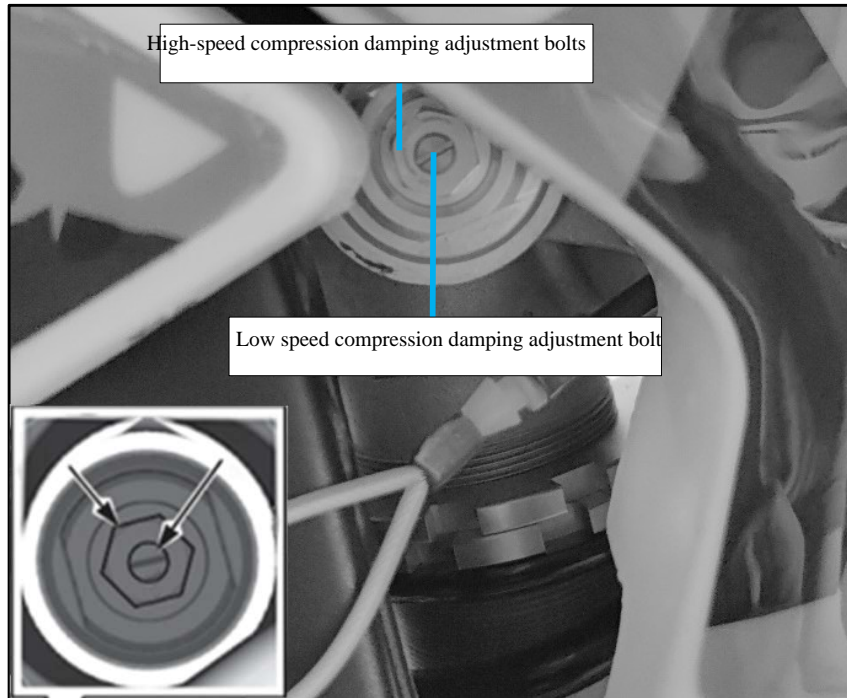

### Low speed compression damping adjustment bolt

When damping adjustment is required at relatively low speeds, low-speed compression damping adjustment bolts should be used. The low-speed compression damping adjustment bolt has 16 sections, each with 1/4 turn.

The shock absorber stiffens after turning clockwise (H) and softens after turning counterclockwise (S). The adjustment torque does not exceed 0.5Nm.

Adjust to standard position:

1. Rotate the adjusting bolt clockwise (H) until it no longer turns the position (hardest).
2. Turn the adjustment bolt 8 segments counterclockwise from the hardest position, and hear the clicking sound at the position.

## Rebound damping adjustment

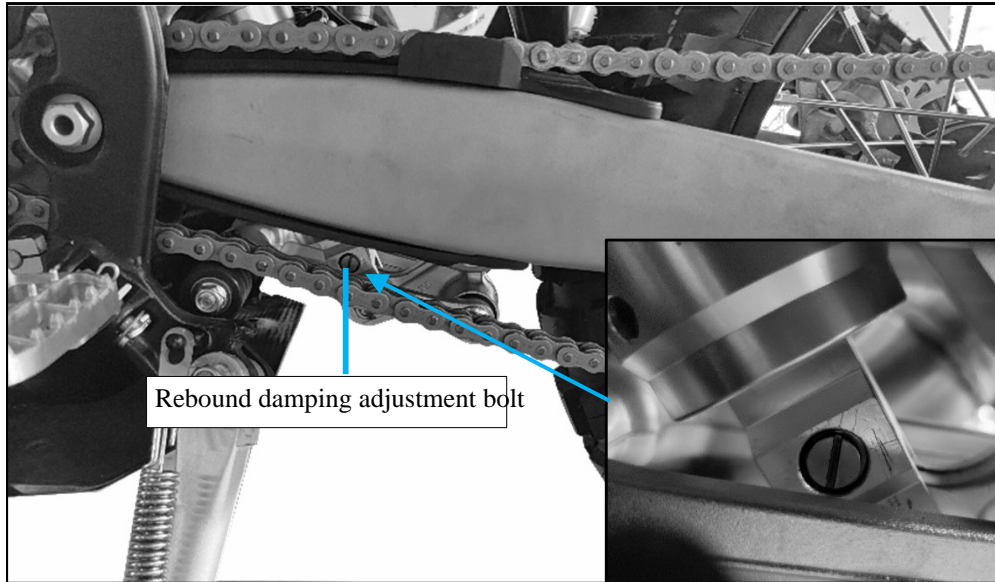

The rebound damping adjustment bolt is located at the lower left end of the rear shock absorber, turning the adjusting bolt clockwise to increase the rebound damping (hard), and turning the adjusting bolt counterclockwise to reduce the rebound damping (soft).

### Attention

- Gently rotate the adjusting bolts to prevent damage to the rear shock absorber.
- When adjusting the rebound damping adjustment bolt, be sure to use a tool of the right size to avoid damage.
- Make sure the adjusting bolts are firmly in the fixed position for each adjustment.
- The adjustment torque does not exceed 0.5Nm.

### Setting the standard rebound damping:

1. Turn the rebound damping adjustment bolt clockwise (H) until it no longer rotates the position;
2. Turn the adjusting bolt in a counterclockwise direction (S, lighter), the standard rebound damping is rotated 10 segments from the hardest position, and a click is heard.

## Headlight

### Adjust the front headlight beam

You can adjust the angle of the headlight beam by rotating the adjustment screw, and rotate clockwise to make the headlight beam descend as a whole; Rotate counterclockwise to raise the headlight beam as a whole, please comply with local laws and regulations.

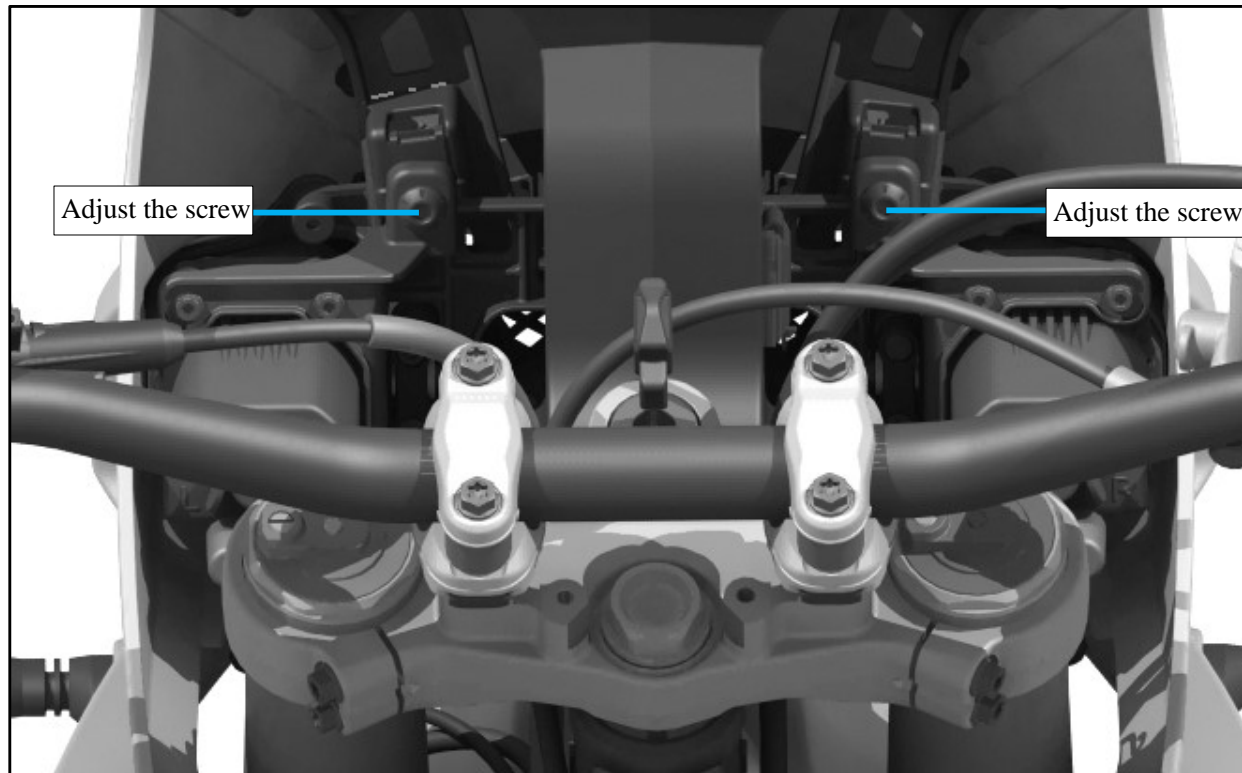

# Troubleshooting

Please read "Maintenance" and "Maintenance Specification" carefully before maintenance, please refer to "Technical Parameters" for maintenance data.

The engine doesn't start .....	63
The warning light is on or flashing .....	64
Puncture the tire .....	65
Disassemble the tire .....	66
Electrical failure.....	70

## The engine doesn't start

### The starter motor runs, but the engine fails to start

**Check the following items:**

- Check that the correct engine starting sequence is being used.
- Check the tank for gasoline.
- Check whether the battery voltage is too low.
- Check whether the side bracket flame-out switch and roll sensor are normal.

### The starter motor isn't working

**Check the following items:**

- Confirm that the engine starting sequence is correct.
  - Make sure the engine kill switch is in the running position.
  - Check whether the battery voltage is too low, whether the fuse is blown, and whether the battery connection is met
- Loose, if the problem persists, please take it to the Kove special repair shop for repair.

**Attention**

- Continuing to ride while the engine is overheating can seriously damage the engine.
- The engine runs at high speed in neutral gear for a long time, which may cause the water temperature to be too high alarm.

### Overheating (water temperature alarm indicator on)

If the engine overheats when the water temperature alarm indicator is on and the speed is slow, please push the motorcycle to a safe side of the road and take the following measures:

1. Turn off the engine with the ignition switch and rotate to the "⊖" (on) position.
2. Check whether the radiator fan is running normally, and then turn the ignition switch to the "⊗" (off) position.

**If the fan isn't running:** Do not start the engine and take your motorcycle to a Kove repair shop.

**If the fan is running:** Leave the ignition in the "⊗" (off) position and wait for the engine to cool.

3. After the engine cools down, check whether the radiator hose is leaking. **If there is a leak:** Do not start the engine, transport your motorcycle to the Kove Repair Shop for service.
4. Check the coolant level in the reservoir and add if necessary.
5. If all 1– 4 checks are normal, you can continue riding, but keep an eye on the indicators.



## The warning light is on or flashing

### ABS fault indicator (Anti-lock Braking System)

If any of the following conditions appear in the ABS fault indicator, it means that your ABS is faulty, and the emergency braking will not be able to provide anti-lock braking function, please hand it over to Kove special maintenance shop for maintenance as soon as possible.

- The ABS fault indicator is solid or flashing while riding.
- When the ignition switch rotates from "⊗" (off) to "○" (on) state, the indicator does not light up.
- The speed is higher than 5 km / h, the indicator doesn't go out.

The ABS fault LED may flash or stay on when the following conditions occur:

- Turn the front wheels individually.
- Turn the rear wheels individually.
- The rear wheels slip.
- When riding on special surfaces.

The ignition can be rotated to the "⊗" (off) position and then to the "○" (on) position to power the system back on and reset.

### EFI fault indicator

If the EFI fault indicator lights up while riding, there may be a serious problem with your EFI system. Please slow down and hand over to the Kove repair shop for maintenance as soon as possible.

## Puncture the tire

Repairing tires or removing wheels requires special tools and expertise, and we recommend leaving such repairs to a Kove Service Shop. If you have done emergency tire repair, please be sure to go to Kove Special Repair Shop to check or replace the tire.

### Repair and replacement of inner tubes

If the inner tire tube is punctured or damaged, you should replace it as soon as possible. Repaired tires, which do not perform as well as new tires, have the potential to crack while you ride.

If you need to temporarily patch an inner tube by patching it or using sealant, drive carefully at a lower speed, then change the tube before the next drive, and after replacing the tube, check the tire carefully.



### Warning

- It is dangerous to ride a motorcycle with temporary tire repairs, and if temporary repairs fail, accidents can occur resulting in serious casualties.
- If you have to ride a motorcycle with temporarily repaired tires, please ride cautiously and slowly, not more than 50 kilometers per hour, until the tires are replaced with new ones.

Disassemble the tire

Front wheel

If you need to remove the wheel to repair the tyre, follow these steps, being careful not to damage the wheel speed sensor and ABS ring gear when you remove and install the wheel.

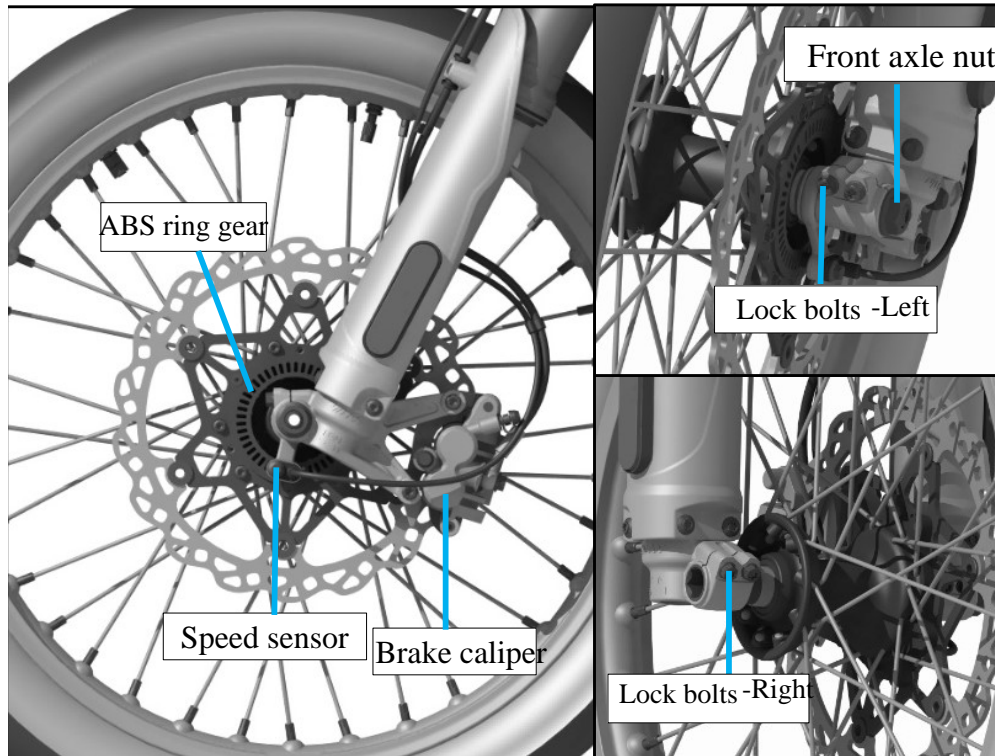

Disassembly

1. Firmly support your motorcycle with a maintenance bracket or crane and lift the front wheels off the ground.
2. Remove the left brake caliper.
  - Support the brake caliper assembly, do not hang on the brake hose, and do not twist the brake hose.
  - Avoid getting lubricating oil, oil or dirt onto the discs or pads.
  - When the brake calipers are removed, do not pull the brake lever.
  - Be careful not to scratch the wheels when the brake calipers are removed.
3. Loosen the left and right axle locking bolts and front axle nuts.
4. Remove the front axle and front wheel.

## Installation

1. Place the front wheel in the middle of the front shock absorber, put the front wheel bushing (left) into the left mounting hole of the front wheel, and the brake disc snaps into the brake caliper.
  2. Pass the slightly lubricated front axle through the front wheel from right to left, tighten the front axle nut, and then install the front axle locking bolt. (Front axle M16, torque: 88Nm; Front axle locking bolt M8, torque: 22Nm)
  3. Install the brake calipers and tighten the bolts. (Torque: 32Nm)
    - ▶ To prevent the brake calipers from scratching the wheels during installation, use new mounting bolts when installing the brake calipers.
  4. Place the front wheels on the ground.
  5. Operate the brake lever several times, then shake the fork up and down several times.
  6. Lift the front wheel off the ground again, and after you release the brake lever, check that the wheel turns smoothly.
- If the torque wrench is not used during installation, please take it to the Kove repair shop as soon as possible, improper installation will cause the braking performance to deteriorate.

### Attention

- To prevent the wheels or calipers from being scratched when attaching them in place, carefully install the discs between the pads.
- When installing the front wheel, you must first tighten the front wheel axle, and then tighten the locking bolts on the left and right sides of the front wheel axle, and the order of the two is not interchangeable.

## Rear wheel

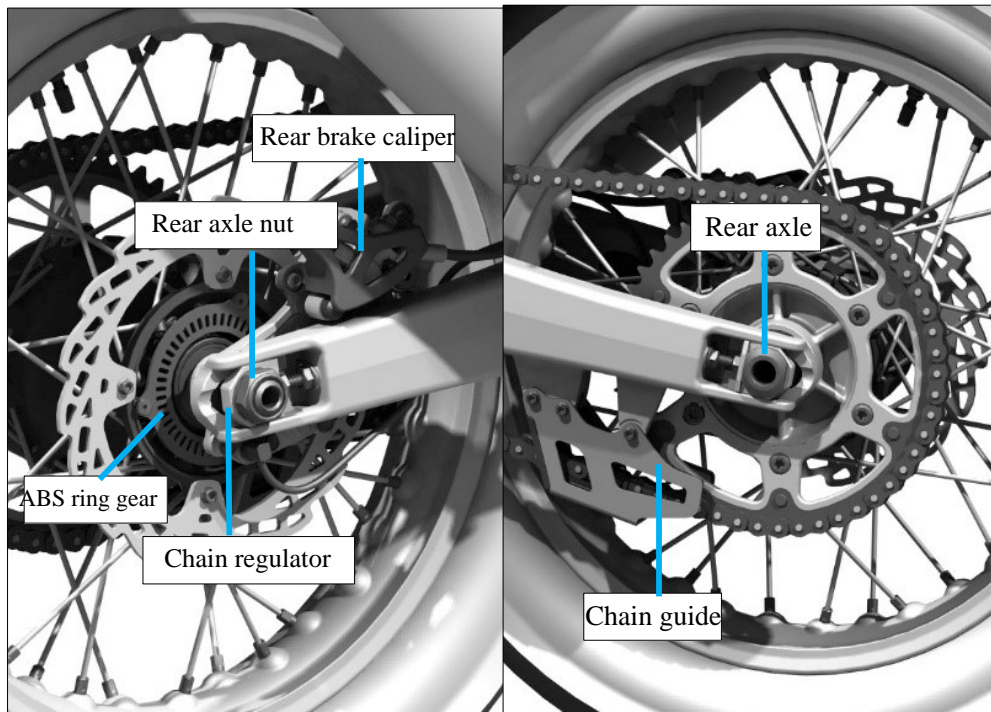

### Disassembly

1. Park your motorcycle on a solid level.
2. Firmly support your motorcycle with side brackets or maintenance brackets and lift the rear wheels off the ground.

3. Remove the left brake caliper.
  - Support the brake caliper assembly, do not hang on the brake hose, and do not twist the brake hose.
  - Avoid getting lubricating oil, oil or dirt onto the discs or pads.
  - Do not operate the brake pedal when the brake caliper is removed.
  - Be careful not to scratch the wheels when the brake calipers are removed.
4. Remove the rear axle nut, chain tightening adjustment nut and chain adjuster.
5. Take out the rear wheel axle for a certain length so that the rear wheel can move forward and remove the chain from the rear sprocket.
6. Hold the rear wheel and remove the rear wheel axle and rear wheel.

## Installation

Install the rear wheels in the reverse order of disassembly, preventing the brake calipers from scratching the wheels during installation.

1. Check whether the rear wheel bearing is damaged or worn, if the bearing is damaged or worn, it is necessary to replace the rear wheel shaft bearing and apply lubricating oil to the bearing.
2. Clean the axles and apply a little grease.
3. The brake disc snaps into the brake caliper.
4. Install the rear wheel, insert the rear wheel axle and chain adjuster.
5. Attach the chain and adjust the chain sag.
6. Tighten the rear axle nut and chain elastic adjustment nut.
7. Place the rear wheel on the ground and check if the wheel turns smoothly.

If the torque wrench is not used during installation, please take it to the Kove repair shop as soon as possible, improper installation will cause the braking performance to deteriorate.

### Attention

- When attaching wheels or calipers to their place, carefully install the discs between the pads to prevent scratches.

## Electrical failure

### The fuse is blown

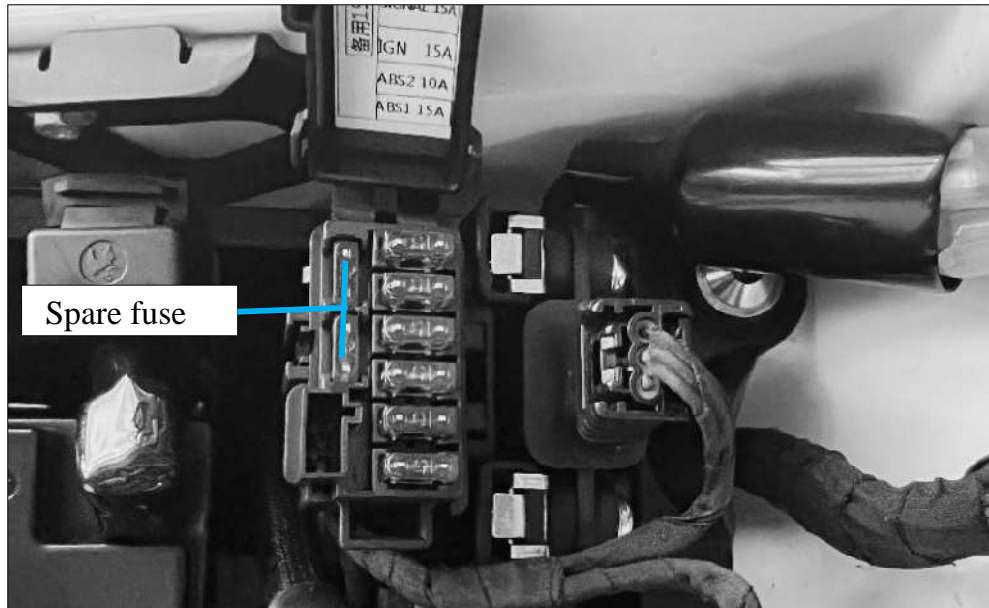

### The battery is dead

Please charge the battery with a special charger for motorcycle lithium batteries, and remove the battery from the motorcycle before charging. If the battery still does not recover after charging, please contact the Kove Special Repair Shop.

### Fuse replacement

1. Remove the seat cushion.
2. Open the fuse box cover, take out the fuse, and check whether the fuse is blown. If it blows, be sure to replace it with a spare fuse of the same specification.
3. Close the fuse box cover and install the seat cushion.

#### Attention

- It is forbidden to charge with a car battery charger or motorcycle lead-acid battery charger, which may cause battery damage or even fire.
- Before handling the fuse, refer to "Checking and Replacing the Fuse".

# Related information

Key .....	72
Gauges, controls, and other features .....	73
Maintenance of motorcycles .....	74
Storage of motorcycles .....	77
Transportation of motorcycles .....	77
You and the environment .....	78
Frame number, engine number, nameplate .....	79
Catalytic converters .....	80



## Key

### Ignition key



The motorcycle has two ignition keys, which are used to start the engine.

- Do not bend the key or subject it to excessive pressure.
- Avoid prolonged exposure to the sun or high temperatures.
- Do not grind, punch or change its shape in any way.

#### Attention

- In order to prevent loss, please take good care of your keys and make a copy immediately if you are worried about losing them.

## Gauges, controls, and other features

### Ignition switch, engine flame-out switch

#### Ignition switch,

1. When parking, please set the ignition switch to the "⊗" or "🔒" position to avoid unnecessary loss of the battery, which will cause excessive battery power loss and will cause it to not start.

2. While riding, do not rotate the key.

#### Engine flame-out switch

Do not use the engine kill switch except in an emergency. Doing so while riding can cause the engine to stop suddenly, making the ride unsafe.

### Odometer, Chronometer (subtotal mileage)

#### Odometer,

When the reading exceeds the 999999, the display locks at the 999999.

#### Chronometer

When the meter's reading exceeds 999.9, it is automatically cleared.

## Maintenance of motorcycles

Frequent cleaning and polishing ensure that the motorcycle lasts for a long time, and a clean motorcycle is more likely to detect potential failures, especially noting that the anti-icing seawater and salt spilled on the road will accelerate the formation of corrosion, and it is important to thoroughly clean the motorcycle after driving along the coast or on the above-mentioned treated roads.

### Clean

Wait for the engine, muffler, brakes and other hot parts to cool before cleaning.

1. Rinse the motorcycle thoroughly with low-pressure hose water to remove loose dirt.
2. If necessary, use a sponge or soft towel dipped in flexible detergent to remove the dirt on it.
3. Rinse the motorcycle thoroughly with enough clean water and dry it with a clean, soft cloth.
4. After drying the motorcycle, lubricate the moving parts to make sure that no lube oil spills on the brakes or tires; Oil-contaminated brake discs, brake pads, brake drums, and brake shoes will have a greatly reduced braking performance and may cause accidents.
5. After washing and drying the motorcycle, lubricate the drive chain immediately.
6. Waxing can prevent corrosion. Avoid products containing strong stain removers or chemical solvents that can damage metal, paint and plastic parts of motorcycles; Do not wax tires and brakes. If your motorcycle has parts with matte paint, do not wax on these matte paint.

## Cleaning precautions

- Do not use high-pressure water guns:
  - ▶ High-pressure water cannons can damage moving and electrical parts beyond repair.
  - ▶ Moisture from the air intake may be drawn into the throttle body or into the air filter.
    - Do not use water to flush the muffler directly:
  - ▶ Water ingress in the muffler can cause the muffler to fail to start and the muffler to rust.
    - Drying brake:
      - ▶ Water will reduce braking performance, after cleaning, you should intermittently use the brake at low speed, repeatedly press the brake pedal, and use the heat generated by brake friction to dry the water until the braking efficiency is restored.
- Do not rinse directly under the seat cushion with water:
  - ▶ Water getting into the seat compartment can damage your documents and other items.
- Do not rinse the area near the headlamp directly with water:
  - ▶ After washing or when cycling in the rain, the internal lens of the headlamp may temporarily fog up, which will not affect the function of the headlamp. However, if you notice a large amount of water or ice accumulating in the lens, please refer it to a Kove repair shop for inspection.
    - ▶ Clean the matte paint finish with plenty of water and mild detergent and dry it with a soft, clean, clean cloth.
- Do not wax and polish matte paint:

## Aluminum components

Aluminum can be corroded after contact with dirt, mud or salt, clean aluminum parts regularly and follow these guidelines to prevent scratches:

- Do not use stiff brushes, steel wool balls or other abrasive cleaning products.
- Do not drive or scratch on the curb.

## Panel

Follow these guidelines to prevent scratches and damage:

- Wash gently with a sponge and enough water.
- Clean with diluted detergent and wash thoroughly with plenty of water to remove stubborn dirt.
- Please avoid contact with corrosive liquids such as gasoline and brake fluid on the instrument panel and lampshade.

## Moving parts

Anti-rust oil can effectively prevent mechanical rust, when car washing or heavy rain, you can apply anti-rust oil on the moving parts of the motorcycle, such as engine output shaft, off

Closer cables, side brackets, shift levers, etc.

## Muffler

The muffler is stainless steel, but it can also be dirty due to mud or dust, which can be removed with a wet sponge dipped in detergent, then carefully rinsed with clean water and dried with suede or a soft towel. If necessary, burn marks can be removed with commercially available compounds with a fine texture and then rinsed in the same way as mud and dust.

If the muffler has been painted, use a neutral stain remover to clean the exhaust pipe and muffler paint, and if you are unsure whether the muffler has been painted, contact the Kove Repair Shop.

### Attention

- Although the muffler is stainless steel, it can also rust. Once found, remove all traces and dirt immediately.

## Storage of motorcycles

If you leave your motorcycle outdoors, you should consider using a motorcycle full body shield. If you don't ride for a long time, follow these guidelines:

- Wash the motorcycle and wax all paint surfaces (except matte paint) and apply anti-rust oil to all chrome parts.
- Lubricate the drive chain.
- Place the motorcycle on the maintenance stand and raise it with a wooden block so that both tires are off the ground at the same time.
- After it rains, remove the body cover and let the motorcycle dry.
- Remove the battery to prevent discharge.

Fully charge the battery and place it in a cool and ventilated place, and if you leave the battery in place, disconnect the negative terminal to prevent discharging. Before reusing the stored motorcycle, check all items required on the maintenance cycle.

## Transportation of motorcycles

If your motorcycle needs to be transported, a motorcycle trailer, a flatbed truck loaded with ramps or lifting platforms should be used, and motorcycle straps should be used. Never try to drag a motorcycle with its wheels on the ground.

### Attention

- Towing a motorcycle can seriously damage the gear.

## You and environment

Owning and riding a motorcycle is enjoyable, but you have to do your duty to protect the environment.

### Choose the right detergent

Use biodegradable stain removers when washing motorcycles and avoid sprays containing chlorofluorocarbons (CFCs) as it destroys the protective layer of the atmosphere (the ozone layer).

### Waste recycling

Separate engine oil and other toxic waste in approved containers and send them to a recycling center, call your local national public affairs or environmental services office to find a recycling center in your area, as well as instructions on how to dispose of non-recyclable waste, do not dump used engine oil in the trash, sewers, or the ground, as used oil, gasoline, coolant, and cleaning solvents contain toxic substances that can harm cleaning workers, contaminate drinking water, lakes, rivers, and the sea.

## Frame number, engine number, nameplate

The frame number and engine number are required for motorcycle registration, which are unique and used to identify your motorcycle and may be required when ordering replacement parts, please keep these numbers on record and keep them in a safe place.

### Frame Number

The frame number is engraved on the left side of the frame riser



### Engine Number

The engine number is engraved on the left side of the engine block



### Nameplate

The nameplate is affixed to the front of the diagonal tube in front of the frame





## Catalytic converters

The motorcycle is equipped with a three-way catalytic converter. The catalytic converter contains precious metals as high-temperature chemical reaction catalysts to convert hydrocarbons (HC), carbon monoxide (CO) and nitrogen oxides (NO<sub>x</sub>) in the exhaust gas into a regulatory-compliant mixture.

A faulty catalytic converter can pollute the air and degrade your engine's performance, so be sure to use original Kove parts when replacing. Follow these guidelines to protect your motorcycle's catalytic converter:

- Use only unleaded gasoline, which can damage the catalytic converter.
- Keep the engine in good working order.
- If the engine does not catch fire, backfire, stall or other bad running, please stop riding immediately, turn off the engine, and hand over the motorcycle to the Kove Motorcycle Special Service Shop for maintenance.

# Technical Specifications

Motorcycle related specs.....	82
Torque specs.....	84
Frame tightening torque.....	85

## Motorcycle related specs.-1

Model	ZF400LS	Engine model	Z194YMQ
Length (mm)	2190	Bore(mm)× stroke(mm)	94.5×64.0
Width (mm)	805	Compression ratio	12.5:1
Height (mm)	1390	Max.net power (KW/r/min)	38±2%/9500±1.5%
Wheelbase-high-seat edition (mm)	1490	Max. torque (N·m/r/min)	40±2%/7000±1.5%
Wheelbase-low-seat edition (mm)	1475	Idle speed (r/min)	1500±150
Curb weight (kg)	155	Cylinder working volume (ml)	449
Payload (kg)	75	Spark plug	CR8E
Front tire specifications	90/90-21	Spark plug gap (mm)	0.7-0.8
Rear tire specifications	140/80-18	Valve clearance (mm)	Intake valve:0.10
Max. speed (km/h)	170		Exhaust valve:0.15

## Motorcycle related specs.-2

Lubricating oil capacity(L)	1.8	Main fuse	30A
Gasoline capacity(L)	14	Headlamps	LED
Primary gear ratio	2.286	Headlights	LED
First gear	2.357	Rear position light/brake light	LED
Second gear	1.824	Front turn signals	LED
Third gear	1.474	Rear turn signals	LED
Fourth gear	1.82	Neutral lights	LED
Fifth gear	1.000	Rear license plate light	LED
Sixth gear	0.846	Turn indicator	LED
Final gear ratio	3.769	Gauge indicator	LED
Battery	12V 4Ah	Ignition method	ECU control ignition

## Torque specs.

Fastener type	Torque (N • m)	Fastener type	Torque (N • m)
5mm bolts and nuts	6	6mm screws	8
6mm bolts and nuts	12	6mm flange bolt (8mm head: small flange)	10
8mm bolts and nuts	22	6mm flange bolt (8mm head: big flange)	12
10mm bolts and nuts	60	6mm flange bolt (10mm head) and nut	12
12mm bolts and nuts	80	8mm bolts and nuts	22
5mm screws	5	/	/

### Attention

- In addition to the specified torque, this vehicle adopts the standard torque values in the table above.

### Frame tightening torque

Assembly position	Torque (N • m)	Fastener type	Torque (N • m)
Self-tapping nails connecting the front brake fluid pipe pressure plate to the front shock absorber trim	ST4. 8	1	
Self-tapping nails for rear fender mud liner, rear fender rear section connection	ST4. 8	1	
Self-tapping nails for OBD to electrical bracket connection	M4. 2	1	
Screws connecting the rear fender rear section lower cover to the tail trim	M5	3	
Rear fender rear section lower cover plate and rear fender rear section connection screw	M5	3	
Hexagon socket countersunk head screws connecting the fuel tank connector mounting plate to the left and right rear fuel tanks	M5	5	
Hexagon socket countersunk head screws for oil level sensor mounting plate and left fuel tank connection	M5	5	
Phillips pan head screws for oil pump and tank connection	M5	5	
Phillips pan head screws for instrument to cowl bracket connection	M5	4	
Phillips pan head screws for position light and tail trim connection	M5	4	
Phillips pan head screws connecting the tail light to the rear section of the rear fender	M5	4	
Hexagon socket step screw for rear tailcap to rear fuel tank connection	M5	4	
Inner six-flower step screws for connecting the front windshield to the front trim of the fuel tank	M5	4	
Hexagon socket countersunk head screws for connecting the front gear ring to the front wheel drum	M5	5	Thread glue
Crossed pan head screws for rear brake pipe clamps and flat fork connections	M5	5	
Internal six-flower hexagonal flange face bolt connecting the rear harness clip to the rear fuel tank	M5	4	
Hexagon socket countersunk head screws for connecting the rear gear ring to the rear drum	M5	5	Thread glue
Cross large pan head screws for fuel filter mounting bracket and fuel tank connection	M5	4	

Assembly position	Thread diameter (mm)	Torque (N·m)	Remark
Hexagon socket head cap screws for connecting headlight bracket pressure plate to headlight bracket	M5	4	
Phillips pan head screws for connecting the sway sensor to the electrical mounting bracket	M5	5	
Cross large pan head screws for ECU to rear fuel tank connection	M5	4	
Hexagon socket countersunk head screws for connecting the seat cushion lock seat to the rear fuel tank	M6	8	
Hexagon socket step screw for connecting front shock trim to front shock absorber	M6	5	
Crossed half-round head screws for chain guard and flat fork connection	M6	8	
Hexagon socket head cap screws for rear brake master cylinder to frame connection	M6	8	
Hexagon socket countersunk head screws for connecting the rear fuel tank protection plate to the rear fuel tank	M6	8	
Inner six-flower hexagonal flange face bolts connecting the electrical bracket to the tank reinforcement bracket	M6	12	
Internal six-flower hexagonal flange face bolts for connecting the electrical bracket to the rear fuel tank	M6	8	
Hexagon socket step screws for connecting the headlight trim to the headlight mounting bracket	M6	8	
Hexagon socket step screws for connecting the water reservoir to the frame	M6	8	
Hexagon socket pan head screws for side bracket flame out switch and side bracket connection	M6	8	
Hexagon socket head screws for connecting the left and right front fuel tanks to the tank mounting bracket	M8	22	
Hexagon socket head screws in front of the left and right front fuel tanks connected to the frame	M8	22	
Hexagon socket head screws for ignition lock to upper coupling plate	M8	22	
Inner six-flower hexagonal flange face bolts for left and right cowl bracket connection	M5	5	
Internal six-flower hexagonal flange face bolts for connecting the oil cooling grid to the lower shield	M5	5	

Assembly position	Thread diameter (mm)	Torque ( N·m )	Remark
Radiator grid delete and radiator connection of internal six flower hexagonal flange face bolts	M5	5	
Inner six hexagonal flange face bolts connecting the shield mounting bracket to the left and right front fuel tanks	M5	5	
Rear brake pedal and rear brake rocker arm connected to the inner six hexagonal flange face bolts	M5	3	Thread glue
Internal six-flower hexagonal flange face bolts connecting the headlight to the headlight mounting bracket	M5	5	
Internal six-flower hexagonal flange face bolts connecting the side bracket hook bracket to the rear fuel tank	M5	5	
Internal six hexagonal flange face bolts for brake handle mounting connection	M6	10	
Internal six-flower hexagonal flange face bolts for oil cooler to frame connection	M6	12	
Hexagonal flange face bolts for connecting the small sprocket cover to the engine	M6	8	
Internal six-flower hexagonal flange face bolts connecting the muffler mounting bracket to the rear fuel tank	M6	10	
Inner hexagonal flange face bolts for connecting the lower shield to the frame	M6	12	
Inner six-flower hexagonal flange face bolts connecting the hood bracket to the headlight bracket	M6	12	
Regulator and electrical bracket connected to the inner six hexagonal flange face bolts	M6	10	
Inner six-flower hexagonal flange face bolts for radiator-frame connection	M6	12	
Front brake fluid pipe clamps and the lower connecting plate connected to the inner six hexagonal flange face bolts	M6	10	
Internal six hexagonal flange face bolts connecting the front disc to the front hub	M6	12	Thread glue
Internal six-flower hexagonal flange face bolts connecting the front fender to the lower connecting plate	M6	8	
Internal six hexagonal flange face bolts for front ABS sensor mounting connection	M6	10	
Injector cap and throttle connection of the inner six hexagonal flange face bolts	M6	8	
Internal six hexagonal flange face bolts for clutch handle mounting connection	M6	10	
Internal six-flower hexagonal flange face bolts for connecting the horn to the frame	M6	12	



Assembly position	Thread diameter (mm)	Torque (N·m)	Remark
Internal six-flower hexagonal flange face bolts for air filter to frame connection	M6	12	
Internal six-flower hexagonal flange face bolts connecting the lower rear fuel tank mounting bracket to the rear fuel tank	M6	10	
Internal six-flower hexagonal flange face bolts connecting the rear fuel tank reinforcement bracket to the rear fuel tank	M6	10	
Inner six hexagonal flange face bolts connecting the rear brake caliper trim to the rear brake caliper	M6	10	
Inner six hexagonal flange face bolts for connecting the rear disc brake disc to the drum	M6	12	Thread glue
Hexagon socket step screws for the connection between the rear water barrier skin and the rear fuel tank	M6	10	
Hexagonal flange face bolts connecting the rear ABS sensor bracket to the rear caliper bracket	M6	12	
Inner hexagonal flange face bolt for connecting the rear ABS sensor to the bracket	M6	8	
Internal six-flower hexagonal flange face bolts for connecting chain guide to flat fork	M6	10	
Internal six-flower hexagonal flange face bolt for connecting headlight bracket to headlight module	M6	12	
Inner six-flower hexagonal flange face bolts for shifter-engine connection	M6	12	
Internal six-flower hexagonal flange face bolts for ABS to ABS bracket connection	M6	12	
Inner six hexagonal flange face bolts for connecting the left and right cowl brackets to the frame	M8	22	Thread glue
Hexagonal bolts for left and right chain adjustment connection	M8	10	
Internal six-flower hexagonal flange face bolts for connecting the middle section of the muffler to the frame	M8	22	
Internal six-flower hexagonal flange face bolts for connecting the rear section of the muffler to the bracket	M8	22	
Internal six-flower hexagonal flange face bolts for lower coupling plate and shock absorbing connection	M8	22	Thread glue
Rear tail cover, rear fender rear section and rear fuel tank connected tail bag mounting bolts	M8	22	
Hexagonal flange face bolts for upper suspension plate to frame connection	M8	35	Thread glue
Internal six-flower hexagonal flange face bolts for upper coupling plate and shock absorbing connection	M8	22	

Assembly position	Thread diameter (mm)	Torque (N·m)	Remark
Internal six-flower hexagonal flange face bolts for the upper mount to lower mount connection	M8	22	
Internal six-flower hexagonal flange face bolts connecting the front brake caliper to the front shock absorber	M8	32	Thread glue
Internal six-flower hexagonal flange face bolts connecting the front shock absorber to the front axle	M8	22	
Brake arm bolt connecting the rear brake arm to the frame	M8	22	Thread glue
Rear fuel tank mounting bolts connected to the frame of the rear fuel tank	M8	22	
Hexagonal flange face bolts connecting the rear section of the rear fender to the rear fuel tank	M8	22	
Internal six-flower hexagonal flange face bolts connecting the front engine suspension plate to the fuel tank mounting bracket	M8	15	
Internal six-flower hexagonal flange face bolts connecting the front engine suspension plate to the frame	M8	22	
Guide sprocket bolt for connecting the guide sprocket to the U-shaped rocker	M8	22	
Internal six-flower hexagonal flange face bolts connecting the lower mount to the upper connection plate	M10	35	Thread glue
Flat head bolts connecting the rear shock to the triangle rocker	M10	60	
Internal six-flower hexagonal flange face bolts for connecting the rear shock absorber to the frame	M10	44	
Hexagonal flange face bolts of the lower engine suspension connected to the engine	M10	54	
Hexagonal flange face bolts for engine upper suspension and bracket connection	M10	60	
Hexagonal flange face bolts for engine front suspension and engine connection	M10	54	
Special bolts for side brackets connected to the frame	M10	10N-m after loosening 1/3 turn, and then stuck tight Bolt hexagonal non-moving tightening nut torque 60N-m	
Hexagonal flange face bolts for connecting U-shaped rocker to frame	M10	60	
Flat head bolts for connecting the triangle rocker to the flat fork	M12	60	
Flat head bolt for connecting U-shaped rocker to triangular rocker	M12	60	

Assembly position	Thread diameter (mm)	Torque (N·m)	Remark
Hexagonal flange face bolts connecting the upper coupling plate to the directional column	M14	80	Lubricate with grease
Hexagonal flange face nut connecting the rear license plate light to the rear section of the rear fender	M5	5	
Hexagonal flange face self-locking nut for muffler rear section and bracket connection	M8	22	
Hexagonal flange face self-locking nuts for engine front suspension plate and frame connection	M8	26	
Hexagonal flange face self-locking nut for bolt connection of guide sprocket to guide sprocket	M8	22	
Hexagonal flange face self-locking nut for the connection of the rear shock and the triangular rocker	M10	60	
Hexagonal flange face self-locking nuts for engine lower suspension and engine connection	M10	54	
Hexagonal flange face self-locking nuts for engine front suspension and engine connection	M10	54	
Front wheel axle nut	M16	88	
Flat fork shaft nut	M16	88	
Rear axle nut	M22	128	
4-slot adjusting nut for steering column locking connection	M25	40N-m, loose then 10N-m back 1/4 Turn	

The logo for ZKOVE, featuring a stylized 'Z' symbol followed by the letters 'KOVE' in a bold, sans-serif font, all in white on a teal background.

ZKOVE

TIBET NEW SUMMIT MOTORCYCLE CO. , LTD

ADD:No.598, 4th airport road of industrial concentration center, southwest Airport economic developing zone, Shuang Liu district, Chengdu, Sichuan Province, China.

SERVICE HOTLINE:**023-67842884**